

文石BOOX桌面级墨水屏显示器安装指南

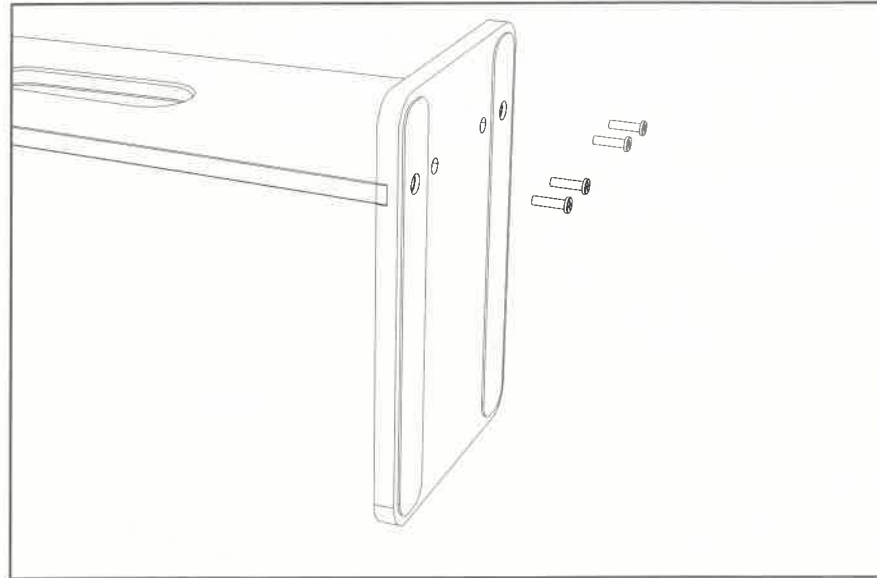

第一步：将显示器支架与底座组装，使用附送的支架螺丝锁紧。

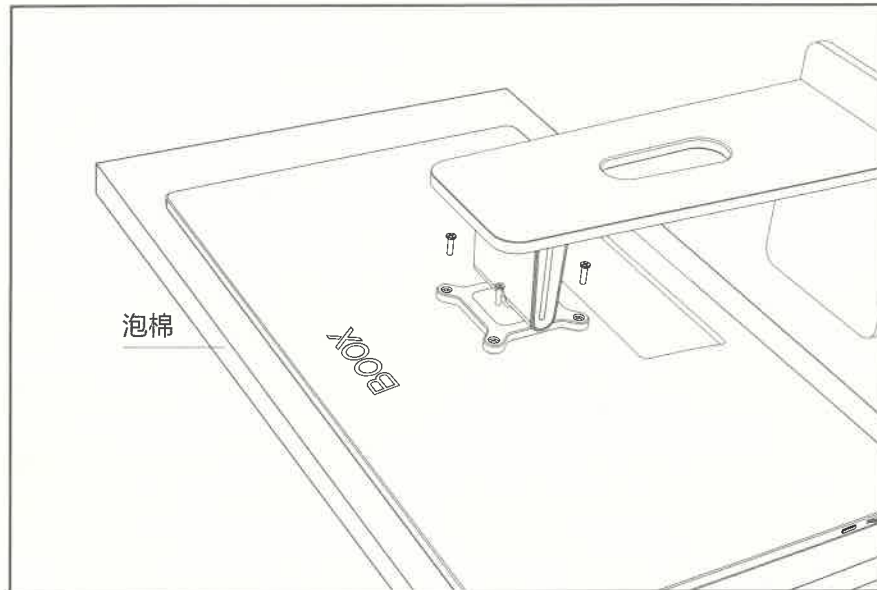

第二步：将显示器的屏幕保护泡棉平放在桌面上，将显示器屏幕朝下放在泡棉上，将显示器底座固定在显示器背后的VESA支架上，并使用附送的螺丝将支架与显示器固定锁紧。

特别注意：

1. 墨水屏为玻璃材质，易碎，请做好屏幕保护。
2. 搬动显示器或调整显示器角度时，手不要直接按压或顶到屏幕，避免屏幕破裂。

BOOX E Ink Monitor Stand Assembling Instruction

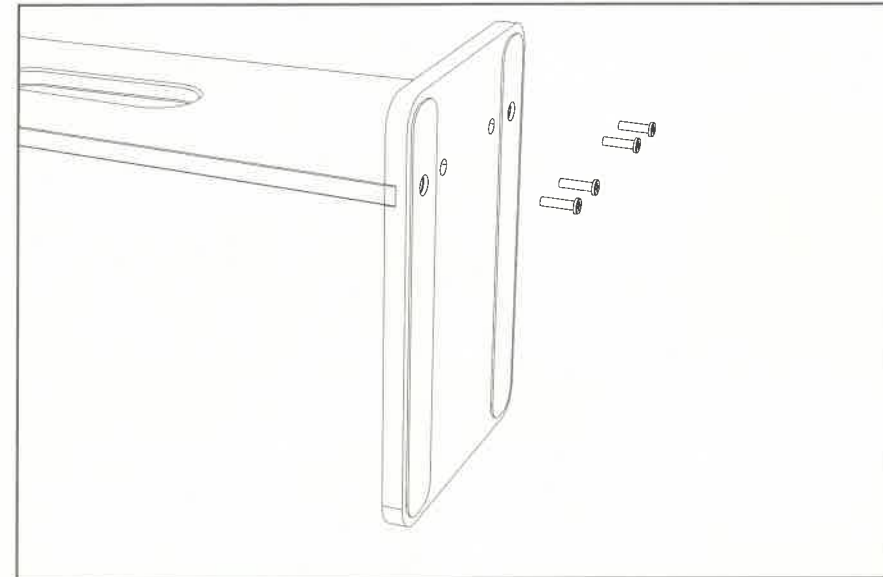

Step 1: Fix the base to the VESA stand using the supplied screws

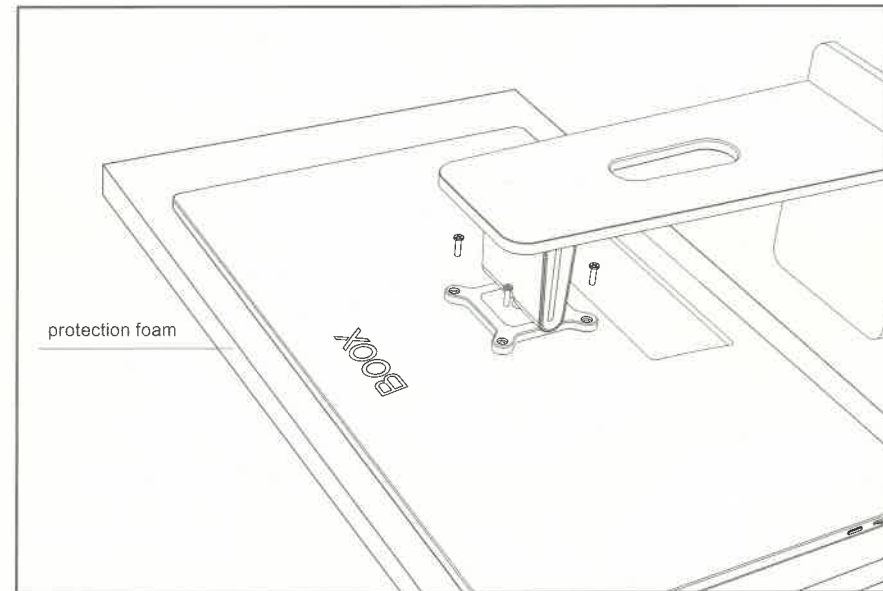

Step 2: Place the monitor screen (face down) on a protection foam. Then mount the VESA stand to the back of the monitor using the supplied screws.

Special Note:

1. The E Ink screen is glass-based and fragile. Please take necessary measures to protect it during the assembling process
2. Do not press directly against the screen using fingers when moving the monitor or adjusting the monitor angles to avoid breaking the screen.

BOOX Mira Pro 护眼墨水屏显示器使用指南

1. 如何与电脑连接?

Type-C接口连接方式 (如下图所示)

使用随机附赠的双Type-C线与电脑全能Type-C接口进行连接, 同时连接显示器电源。

注意: 电脑需要带有“全能Type-C接口或者雷电3及以上接口”, 非全能Type-C接口不支持视频输出。

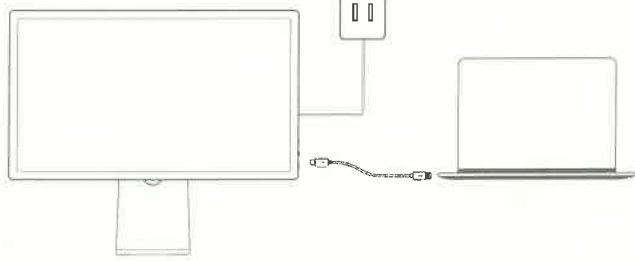

HDMI高清接口连接方式 (如下图所示)

将随机附送的Mini HDMI数据线和Type-C数据线与电脑相连, 同时连接显示器电源。

DP高清接口连接方式 (如下图所示)

将自购的DP数据线和Type-C数据线与电脑相连, 同时连接显示器电源。

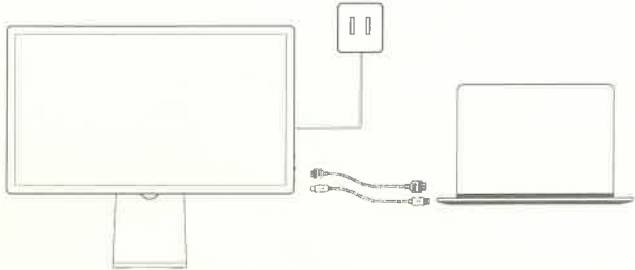

2. 电脑客户端软件

软件默认内置了5种刷新模式

- **极速模式:** 适合日常电脑操作, 浏览网页 日常软件使用。
- **图像模式:** 适用于图片浏览, 观看照片, 可以设定定时刷新页面。
- **文字模式:** 适合专注打字, 文字输入录入。
- **阅读模式:** 适用文字阅读场景。
- **视频模式:** 适用于观看视频, 网课等动态播放。

软件下载地址: <http://zh.boox.com/down/>

您还可以进行根据自己的使用场景创建自定义刷新模式

3. 实体按键功能

- ① **菜单键:** 唤出菜单, 确认功能
- ② **拨轮键:** 上下拨动切换功能
- ③ **电源键:** 短按全刷, 长按开关机

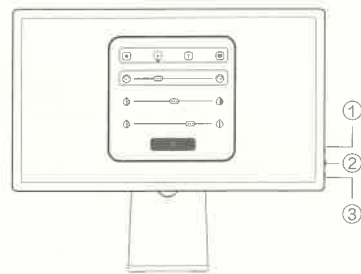

4. 显示模式调节

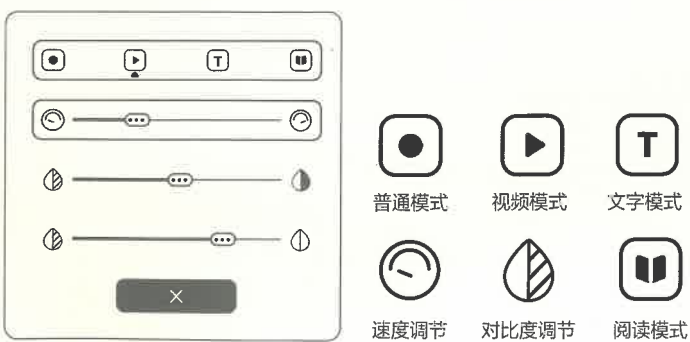

5. 接口说明

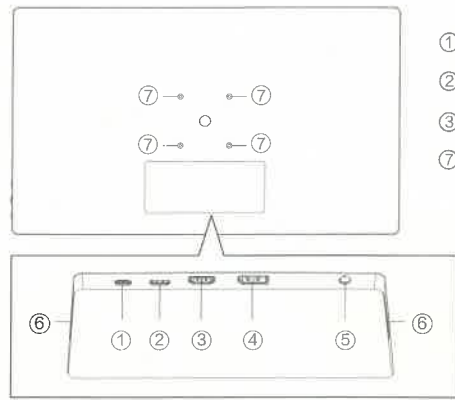

- ① USB-C
- ② Mini HDMI
- ③ HDMI
- ④ DP
- ⑤ DC
- ⑥ 喇叭
- ⑦ VESA接口 (75 x 75)

6. 角度调整

- Mira Pro支持水平方向的角度调整 (图1), 同时支持屏幕90度旋转 (图2)。
- 顺时针90度旋转时, 请先将屏幕抬高高度, 再顺时针旋转90度, 防止旋转时显示屏幕与底座碰撞。



图1



图2

7. 显示器配件

- 12V 3A 电源适配器 X1
- 全能Type-C 数据线 X1
- Type-C 数据线 X1
- HDMI to Mini HDMI 数据线 X1
- VESA螺丝 X4
- VESA支架装配螺丝刀 X1

8. 安全使用指南:



声明:

限于篇幅, 本《快速说明》中所包含的信息并不完整, 请以相关型号《用户手册》具体信息为准。产品图片与实物可能有细微区别, 效果演示图和示意图仅供参考, 有关产品的外观 (包括但不限于颜色) 和功能, 请以实物为准。

广州文石信息科技有限公司 (Onyx International Inc.) 保留对包含在本《快速说明》及《用户手册》中的产品规格和内容做出更改的权利, 如有更改, 恕不另行通知。

更新版本的详细说明书请参见官方网站: <https://www.boox.com/>



扫码获得更多技术支持



客户端下载二维码

BOOX Mira Pro Eye-friendly E Ink Monitor User Guide

1. How to Connect to a Computer

Connect via a Type-C port (As shown below)

Connect Mira Pro to a full-featured Type-C port of your computer via the supplied Type-C cable, and to a power source via a DC charger at the same time

Notice: The computer needs to have a "full-featured Type-C interface or Thunderbolt3 and above interface". The non-full-featured Type-C interface does not support video output.

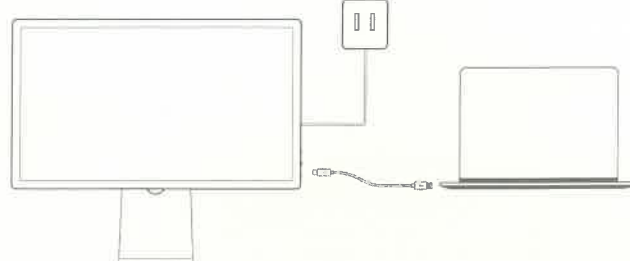

Connect via an HDMI High-Definition port (As shown below)

Connect Mira Pro to a computer via the supplied Mini HDMI cable and Type-C cable, and to a power source via a DC charger at the same time.

Connect via a DP High-Definition port (As shown below)

Connect Mira Pro to a computer via the self-purchased DP cable and the supplied Type-C cable, and to a power source via a DC charger at the same time.

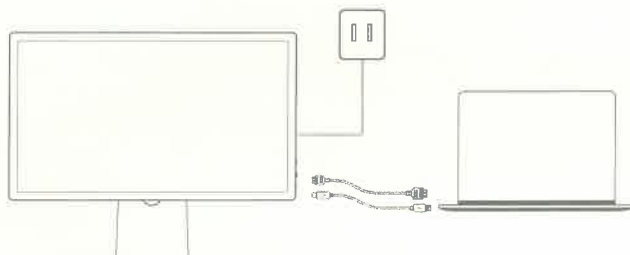

2. Computer Client Software

There are 5 default Refresh Modes

- **Speed Mode:** suitable for daily computer use, web browsing, and daily software use.
 - **Image Mode:** suitable for browsing and viewing images. You can set the Refresh timer.
 - **Text Mode:** suitable for typing and text input.
 - **Reading Mode:** suitable for text reading.
 - **Video Mode:** suitable for dynamic playbacks such as watching videos and online courses.
- Software Download: <https://www.boox.com/support/>
In addition to the 5 default Refresh Modes, you can create your own Refresh Modes according to your personal preferences.

3. Physical Button Function

- ① **Menu:** Call out the menu and confirm function selection
- ② **Scroll Wheel:** Toggle up and down to switch functions
- ③ **Power Button:** Short press to fully refresh the screen and long press to switch on/off

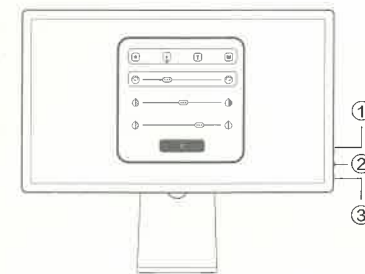

4. Display Mode Settings

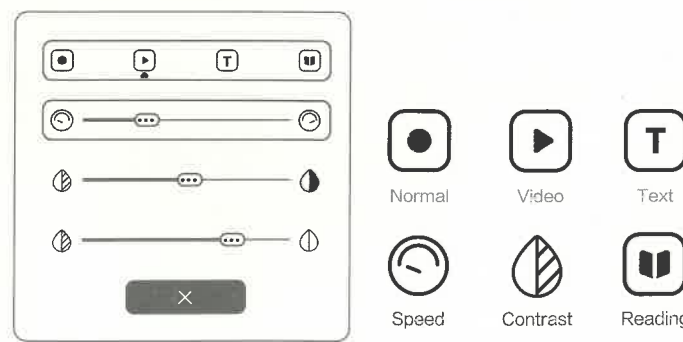

5. Interface Description

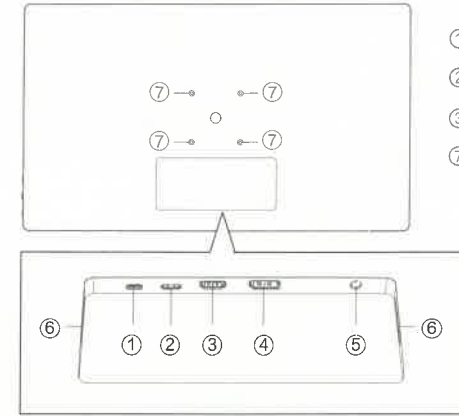

- ① USB-C
- ② Mini HDMI
- ③ HDMI
- ④ DP
- ⑤ DC
- ⑥ Speaker
- ⑦ VESA mounting Interface (75x75)

6. Angle Adjustment

- Mira Pro supports horizontal angle adjustment (Fig. 1) and screen 90-degree rotation (Fig. 2).
- When rotating 90-degree clockwise, please raise the monitor's height first, and then rotate it 90 degrees clockwise to prevent the monitor from bumping into the base



Fig. 1

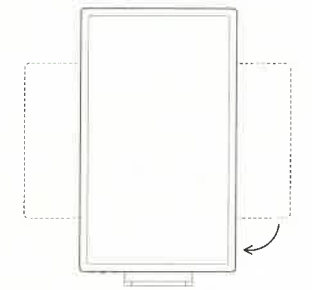

Fig. 2

7. Accessories

- 12V/3A DC Charger (100~240V) x 1
- Full-featured Type-C cable x 1
- USB-C cable x 1
- HDMI to Mini HDMI cable x 1
- VESA screws x 4
- Screwdriver for VESA stand assembling x 1

8. Safety Guidance



Disclaimer:

Due to space limitations, the information contained in this "User Guide" is incomplete. Please refer to the specific information in the "User Manual" of each model. The product picture may be slightly different from the actual product. The demonstration diagram and schematic diagram are for reference only. For the appearance (including but not limited to color) and function of the product, please refer to the actual product.

Onyx International Inc. reserves the right to make changes to the product specifications and content contained in the "User Guide" and "User Manual". We will have no further notice for any changes.

For the latest version, please visit <https://www.boox.com/>