

NewClassic Balances

MS-S / MS-L Models

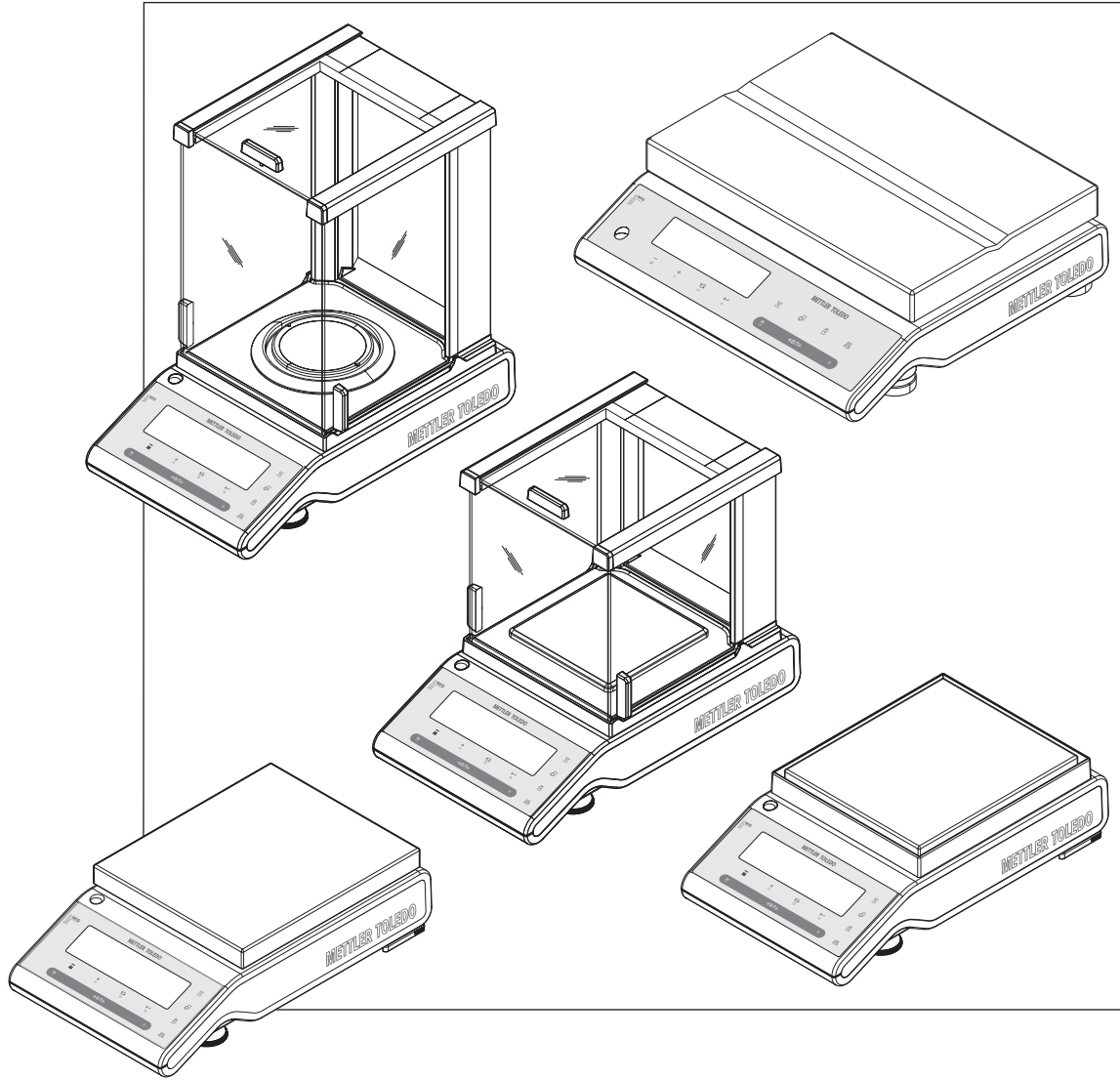

METTLER TOLEDO

Table of contents

1	Introduction		7
	1.1	Conventions and Symbols Used in These Operating Instructions	7
2	Safety Precautions		8
3	Overview		9
	3.1	S Platform	9
	3.2	L Platform	10
	3.3	Operation Keys	11
	3.4	Display Panel	12
4	Setting up the Balance		14
	4.1	Unpacking and Delivery Inspection	14
	4.2	Installing the Components	15
	4.3	Selecting the Location and Leveling the Balance	17
	4.3.1	Selecting the Location	17
	4.3.2	Leveling the Balance	17
	4.4	Power Supply	18
	4.5	Battery Operation	19
	4.6	Transporting the Balance	19
	4.7	Weighing Below the Balance	19
	4.8	Adjustment (Calibration)	20
	4.8.1	Fully Automatic Adjustment FACT	20
	4.8.2	Manual Adjustment with Internal Weight	20
	4.8.3	Manual Adjustment with External Weight	21
5	Weighing Made Simple		23
	5.1	Switching the Balance On and Off	23
	5.2	Performing a Simple Weighing	24
	5.3	Zero Setting / Taring	24
	5.4	METTLER TOLEDO DeltaRange Balances	25
	5.5	Switching Weight Units	25
	5.6	Recall / Recall Weight Value	25
	5.7	Weighing with the Weighing-in Aid	25
	5.8	Print / Transmit Data	26
6	The Menu		27
	6.1	What is in the Menu ?	27
	6.2	Menu Operation	28
	6.3	Description of Menu Topics	29
	6.3.1	Main Menu	29
	6.3.2	Basic Menu	30
	6.3.3	Advanced Menu	31
	6.3.4	Interface Menu	35
7	Application "Piece Counting"		43
8	Application "Percent Weighing"		45
9	Application "Check Weighing"		47
10	Application "Statistics"		49
11	Application "Formulation" (Net Total Formulation)		51
12	Application "Totaling"		53

13	Application "Dynamic Weighing"		55
14	Application "Multiplication Factor Weighing"		57
15	Application "Division Factor Weighing"		59
16	Application "Density"		61
	16.1	Density Determination of Solids	61
	16.2	Density Determination of Liquids	63
	16.3	Formulae Used to Calculate Density	64
17	Application "Routine Test"		67
18	Application "Diagnostics"		70
	18.1	Repeatability Test	70
	18.2	Display Test	71
	18.3	Key Test	72
	18.4	Motor Test	73
	18.5	Balance History	73
	18.6	Calibration History	74
	18.7	Balance Information	75
	18.8	Service Provider Information	76
19	Communication with Peripheral Devices		77
	19.1	Function PC-Direct	77
	19.2	Installing USB Device Interface	78
20	Firmware (Software) Updates		80
	20.1	Operating Principle	80
	20.2	Update Procedure	80
21	Error and Status Messages		81
	21.1	Error Messages	81
	21.2	Status Messages	81
22	Cleaning and Service		83
	22.1	Cleaning the Glass Draft Shield (0.1 mg and 1 mg Models)	83
23	Interface Specification		86
	23.1	RS232C Interface	86
	23.2	USB Device Interface	86
	23.3	MT-SICS Interface Commands and Functions	86
24	Technical Data		89
	24.1	General Data	89
	24.2	Model-Specific Data	89
	24.2.1	Balances with Readability of 0.1 mg, S Platform with Draft Shield	89
	24.2.2	Balances with Readability of 1 mg, S Platform with Draft Shield	90
	24.2.3	Balances with Readability of 0.01 g, S Platform	91
	24.2.4	Balances with Readability of 0.1 g to 1 g, S Platform	93
	24.2.5	Balances with Readability of 0.1 g to 1 g, L Platform	94
	24.2.6	Balances with Readability of 2 g to 5 g, L Platform	95
	24.3	Dimensions	97
	24.3.1	Balances with Readability of 0.1 mg, S Platform With Draft Shield	97
	24.3.2	Balances with Readability of 1 mg, S Platform With Draft Shield	98
	24.3.3	Balances with Readability of 0.01 g, S Platform	99

	24.3.4	Balances with Readability of 0.1 g to 1 g, S Platform	100
	24.3.5	Balances with Readability of 0.1 g to 5 g, L Platform	101
25	Accessories and Spare Parts		102
	25.1	Accessories	102
	25.2	Spare Parts	106
26	Appendix		107
	26.1	Conversion Table for Weight Units	107
27	Index		108

1 Introduction

Thank you for choosing a METTLER TOLEDO balance.

The precision balances of the NewClassic line combine a large number of weighing possibilities with easy operation.

These operating instructions apply to all balance models MS-S and MS-L in the NewClassic line. However, the different models have different characteristics regarding equipment and performance. Special notes in the text indicate where this makes a difference to operation.

1.1 Conventions and Symbols Used in These Operating Instructions

Key designations are indicated by double angular brackets (e.g. «»).



This symbol indicates press key briefly (less than 1.5 s).



This symbol indicates press and hold key down (longer than 1.5 s).



This symbol indicates a flashing display.



This symbol indicates an automatic sequence.



These symbols indicate safety notes and hazard warnings which, if ignored, can cause personal danger to the user, damage to the balance or other equipment, or malfunctioning of the balance.

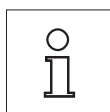

This symbol indicates additional information and notes. These make working with your balance easier, as well as ensuring that you use it correctly and economically.

2 Safety Precautions

Always operate and use your balance only in accordance with the instructions contained in this manual. The instructions for setting up your new balance must be strictly observed.

If the balance is not used according to these Operating Instructions, protection of the balance may be impaired and METTLER TOLEDO assumes no liability.



It is not permitted to use the balance in explosive atmosphere of gases, steam, fog, dust and flammable dust (hazardous environments).



Use the MS-KLIP balance model with Protection Class IP65 if: the balance is used in wet areas, wet cleaning is necessary or the balance is used in a dusty environment. Even with Protection Class IP65. Never flood the balance or immerse it in liquid.

All other balance models may only be used in dry rooms.



Use only the original Universal AC adapter delivered with your balance.

The L platform has a built-in power supply unit. Hazard of electric shock if the power cable is damaged! Check the power cable for damage regularly. Unplug the power cord immediately if the power cable is damaged.



Do not use sharply pointed objects to operate the keyboard of your balance! Although your balance is very ruggedly constructed, it is nevertheless a precision instrument. Treat it with corresponding care.

Do not open the balance: It does not contain any parts which can be maintained, repaired, or replaced by the user. If you ever have problems with your balance, contact your METTLER TOLEDO dealer.

Use only balance accessories and peripheral devices from METTLER TOLEDO; they are optimally adapted to your balance.



Disposal

In conformance with the European Directive 2002/96/EC on Waste Electrical and Electronic Equipment (WEEE) this device may not be disposed of in domestic waste. This also applies to countries outside the EU, per their specific requirements.

Please dispose of this product in accordance with local regulations at the collecting point specified for electrical and electronic equipment. If you have any questions, please contact the responsible authority or the distributor from which you purchased this device. Should this device be passed on to other parties (for private or professional use), the content of this regulation must also be related.

Thank you for your contribution to environmental protection.

3 Overview

3.1 S Platform

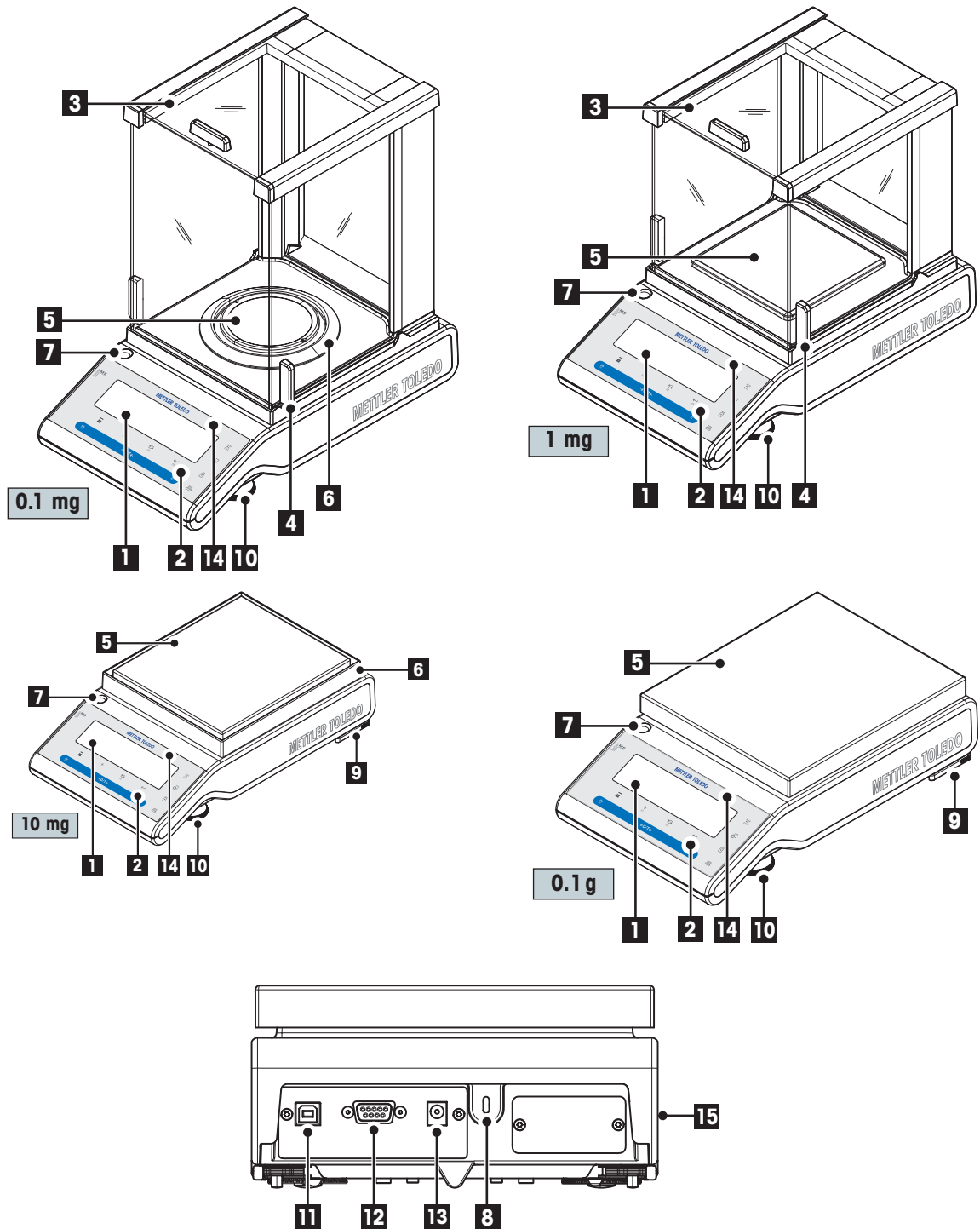

Name and Function of Components	
1	Display
2	Operation keys
3	Glass draftshield
9	Safety feet (with 10 mg, 0.1 g S series models)
10	Leveling foot
11	USB device interface

Name and Function of Components	
4	Handle for operation of the draft shield door
5	Weighing pan
6	Draft shield element
7	Level indicator
8	Kensington slot for anti-theft purposes
12	RS232C serial interface
13	Socket for AC Adapter
14	Model sticker (with approved models only)
15	Product label

3.2 L Platform

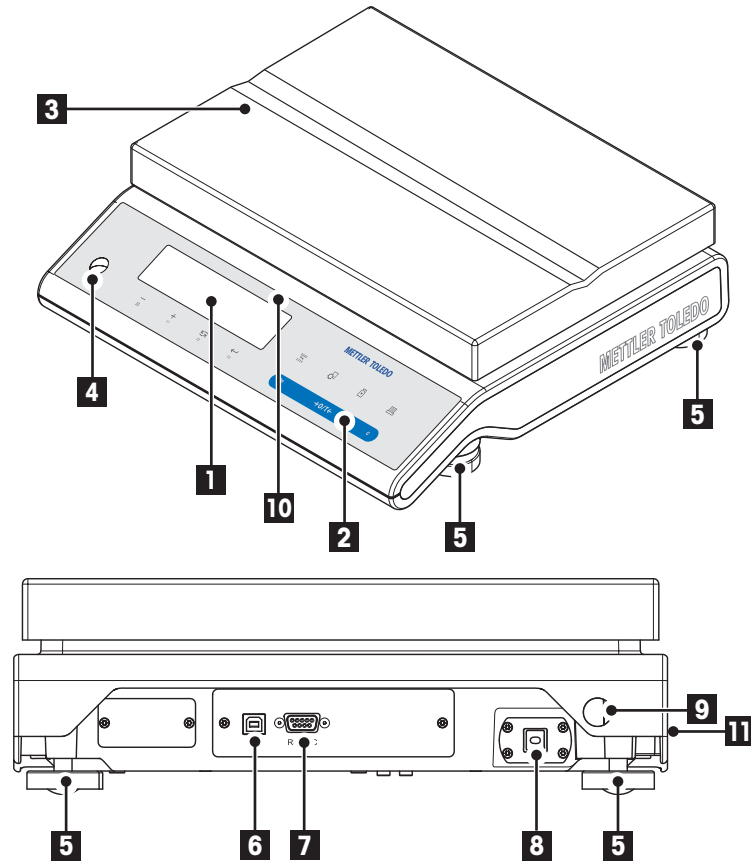

Name and Function of Components	
1	Display
2	Operation keys
3	Weighing pan
4	Level indicator
5	Leveling foot
6	USB device interface
7	RS232C serial interface
8	Power cord with country-specific plug
9	Security slot for anti-theft purposes
10	Model sticker (with approved models only)
11	Product label

3.3 Operation Keys

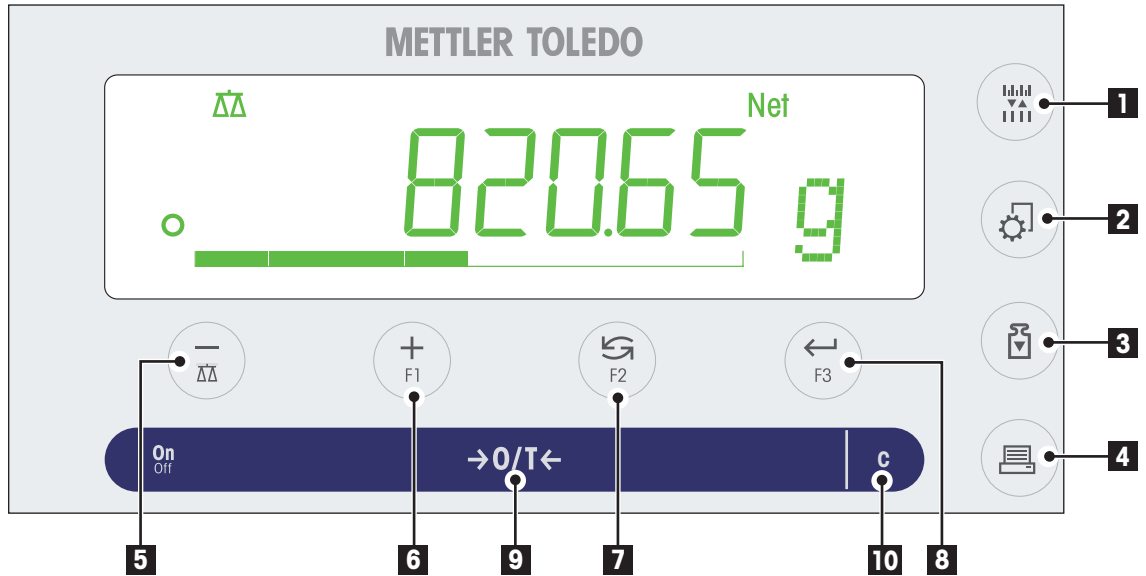

Key Functions







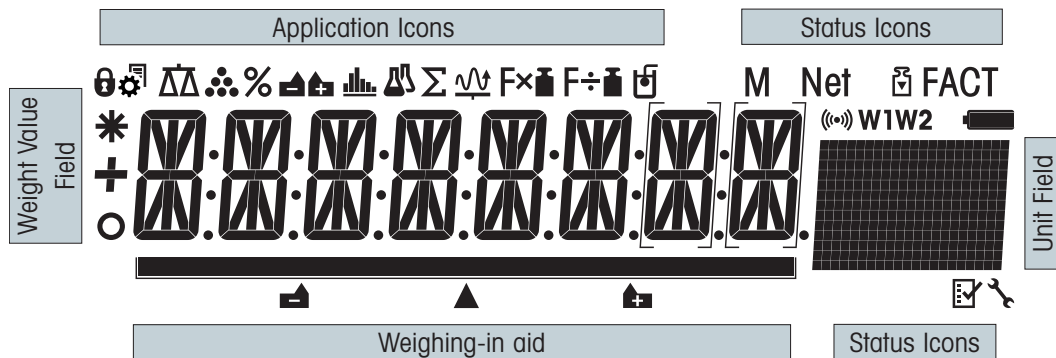

No.	Key	Press briefly (less than 1.5 s)	Press and hold (longer than 1.5 s)
1		<ul style="list-style-type: none"> To change display resolution (1/10d function) while application is running Note: not available with approved models in selected countries. 	no function
2		<ul style="list-style-type: none"> Enter or leave menu (Parameter settings) 	no function
3		<ul style="list-style-type: none"> Execute predefined adjusting (calibration) procedure 	no function
4		<ul style="list-style-type: none"> Printout display value Printout active user menu settings Transfer data 	no function
5		<ul style="list-style-type: none"> To navigate back (scroll up) within menu topics or menu selections Decrease (numerical) parameters within menu and in applications 	<ul style="list-style-type: none"> To select the weighing application Decrease (numerical) parameters quickly within menu and in applications
6		<ul style="list-style-type: none"> To navigate forward (scroll down) within menu topics or menu selections Increase (numerical) parameters within menu and in applications 	<ul style="list-style-type: none"> To select assigned F1 application and entering the parameter settings of application. Default F1 application assignment: Piece counting Increase (numerical) parameters quickly within menu and in applications

No.	Key	Press briefly (less than 1.5 s)	Press and hold (longer than 1.5 s)
7	F2	<ul style="list-style-type: none"> With entries: scroll down To navigate through menu topics or menu selections To toggle between unit 1, recall value (if selected), unit 2 (if different from unit 1) and the application unit (if any) 	<ul style="list-style-type: none"> To select assigned F2 application and entering the parameter settings of application. Default F2 application assignment: Percent weighing
8	F3	<ul style="list-style-type: none"> To enter or leave menu selection (from / to menu topic) To enter application parameter or switch to next parameter To store parameter 	<ul style="list-style-type: none"> To select assigned F3 application and entering the parameter settings of application. Default F3 application assignment: Formulation
9	→0/T←	<ul style="list-style-type: none"> Switch on Zero/Tare 	<ul style="list-style-type: none"> Switch off
10	C	<ul style="list-style-type: none"> Cancel and to leave menu without saving (one step back in the menu). 	no function

3.4 Display Panel



Application Icons			
	Menu locked		Application "Formulation / Net-Total"
	Menu setting activated		Application "Totaling"
	Application "Weighing"		Application "Dynamic weighing"
	Application "Piece counting"		Application "Multiplication factor"
	Application "Percent weighing"		Application "Division factor"
	Application "Check weighing"		Application "Density"
	Application "Statistics"		
Status Icons			
M	Indicates stored value (Memory)		Service reminder
Net	Indicates Net weight values		Acoustic feedback for pressed keys activated
	Adjustments (calibration) started	W1	Weighing range 1 (Dual Range models only)
FACT	FACT activated	W2	Weighing range 2 (Dual Range models only)
	Applications "Diagnostics" and "Routine Test"		Charge of battery: full, 2/3, 1/3, discharged (Battery operated models only)

Weight Value Field and Weighing-in aid						
	Indicates negative values			Brackets to indicate uncertified digits (approved models only)		
	Indicates unstable values			Marking of nominal or target weight		
	Indicates calculated values			Marking of tolerance limit T+		
				Marking of tolerance limit T-		
Unit Field						
	g	gram	ozt	troy ounce	tls	Singapore taels
	kg	kilogram	GN	grain	tlt	Taiwan taels
	mg	milligram	dwt	pennyweight	tola	tola
	ct	carat	mom	momme	baht	baht
	lb	pound	msg	mesghal		
	oz	ounce	tlh	Hong Kong taels		

4 Setting up the Balance



The balance must be disconnected from the power supply when carrying out all setup and mounting work.

4.1 Unpacking and Delivery Inspection

- a) Open the packaging and carefully remove all components.
- b) Check the delivered items.

The standard scope of delivery contains the following items:

Components		S platform				L platform	
		0.1 mg	1 mg	0.01 g	0.1 g	0.1g/1g	2g/5g
Draft shield	236 mm	✓	–	–	–	–	–
	168 mm	–	✓	–	–	–	–
Weighing pan	Ø 90 mm	✓	–	–	–	–	–
	127 x 127 mm	–	✓	–	–	–	–
	170 x 200 mm	–	–	✓	–	–	–
	190 x 226 mm	–	–	–	✓	–	–
	246 x 351 mm	–	–	–	–	✓	✓
Draft shield element		✓	–	✓	–	–	–
Pan support		✓	✓	✓	✓	–	–
Bottom plate		✓	✓	–	–	–	–
Protective cover		✓	✓	✓	✓	✓	✓
Universal AC adapter (country specific)		✓	✓	✓	✓	–	–
Mounted country specific power cable		–	–	–	–	✓	✓
Operating instructions(this document)		✓	✓	✓	✓	✓	✓
Quick Guide		✓	✓	✓	✓	✓	✓
EC declaration of conformity		✓	✓	✓	✓	✓	✓

4.2 Installing the Components

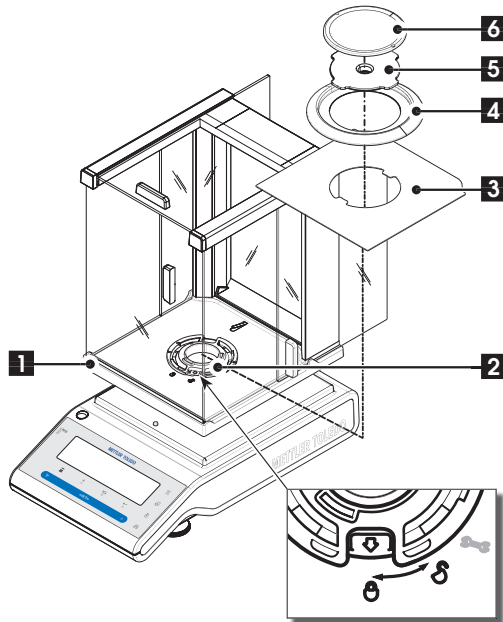

Balances with readability of 0.1 mg, S platform with draft shield (236 mm)

Place the following components on the balance in the specified order:

Note: Push the side glass back as far as will go and grasp the draft shield (1) with both hands on the bars at the top.

- Turn draft shield lock (2) to position "🔓" (unlock).
- Place draft shield on the balance.
- Turn draft shield lock to "🔒" (lock) and place bottom plate (3).
- Place draft shield element (4) and weighing pan (6) with pan support (5).

Note: Cleaning the draft shield see section "Maintenance and cleaning".

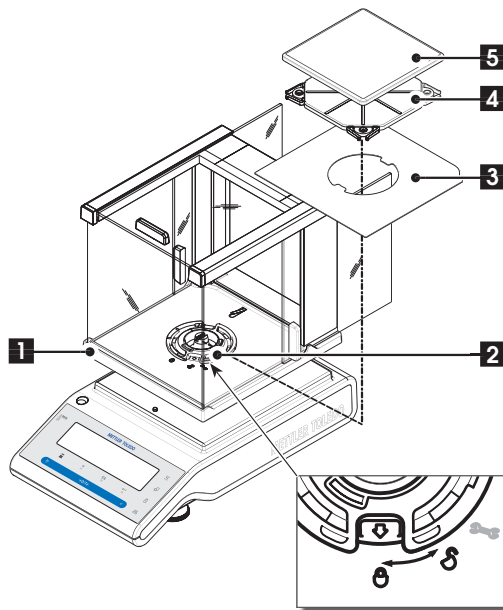

Balances with readability of 1 mg, S platform with draft shield (168 mm)

Place the following components on the balance in the specified order:

Note: Push the side glass back as far as will go and grasp the draft shield (1) with both hands on the bars at the top.

- Turn draft shield lock (2) to position "🔓" (unlock).
- Place draft shield on the balance.
- Turn draft shield lock to "🔒" (lock) and place bottom plate (3).
- Place weighing pan (5) with pan support (4).

Note: Cleaning the draft shield see section "Maintenance and cleaning".

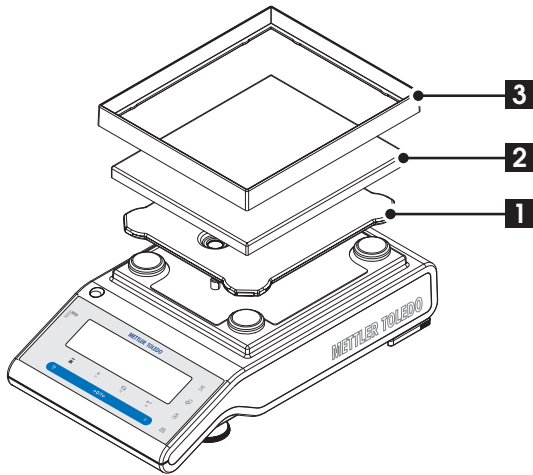

Balances with readability of 10 mg, S platform

- Place the following components on the balance in the specified order:
 - Pan support (1)
 - Weighing pan (2)
 - Draft shield element (3)

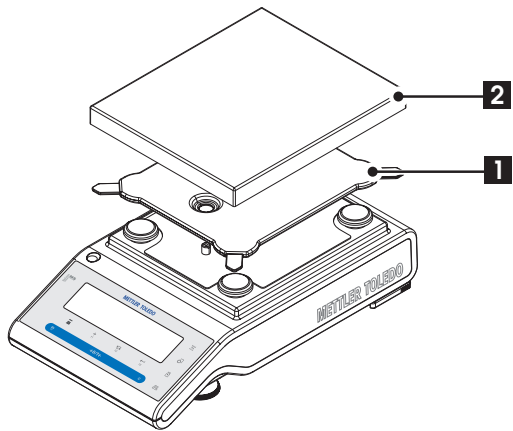

Balances with readability of 0.1 g, S platform

- Place the following components on the balance in the specified order:
 - Pan support (1)
 - Weighing pan (2)

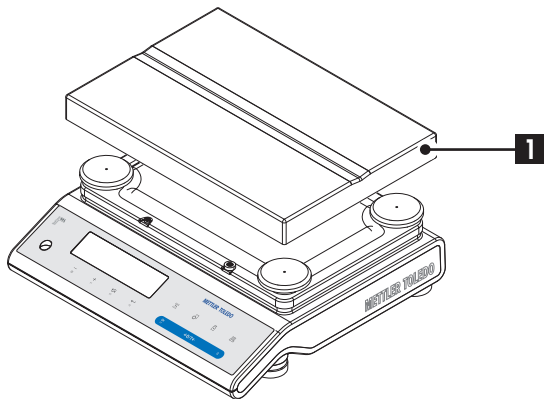

Balances with readability to 1 g, L platform

- Place the weighing pan (1) on the balance.

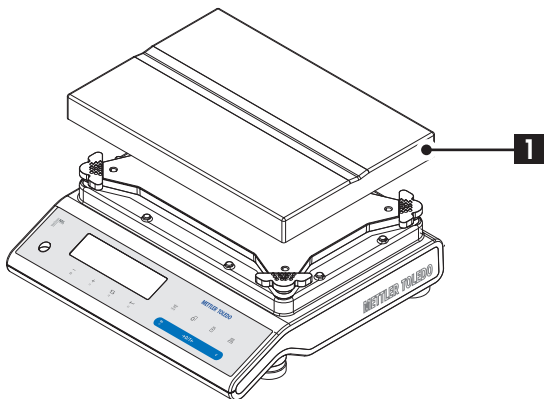

Balances with readability from 2 g, L platform

- Place the weighing pan (1) on the balance.

4.3 Selecting the Location and Leveling the Balance

Your balance is a precision instrument and will thank you for an optimum location with high accuracy and dependability.

4.3.1 Selecting the Location

Select a stable, vibration-free position that is as horizontal as possible. The surface must be able to safely carry the weight of a fully loaded balance.

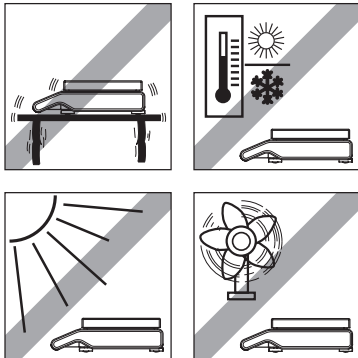

Observe ambient conditions (see Technical Data).

Avoid the following:

- Direct sunlight
- Powerful drafts (e.g. from fans or air conditioners)
- Excessive temperature fluctuations

4.3.2 Leveling the Balance

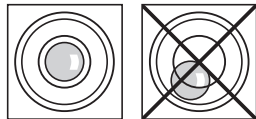

The balances have a level indicator and two (S Platform) or four (L Platform) adjustable leveling feet to compensate for slight irregularities in the surface of the weighing bench. The balance is exactly horizontal when the air bubble is in the middle of the level glass.

Note: The balance should be leveled and adjusted each time it is moved to a new location.

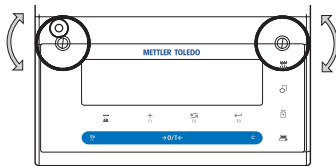

Balances with S platform and readability of 0.1 mg and 1 mg

– Adjust the two leveling feet appropriately until the air bubble comes to rest exactly in the middle of the glass:

Air bubble at	"12 o'clock"	turn both feet clockwise
Air bubble at	"3 o'clock"	turn left foot clockwise, right foot counterclockwise
Air bubble at	"6 o'clock"	turn both feet counterclockwise
Air bubble at	"9 o'clock"	turn left foot counterclockwise, right foot clockwise

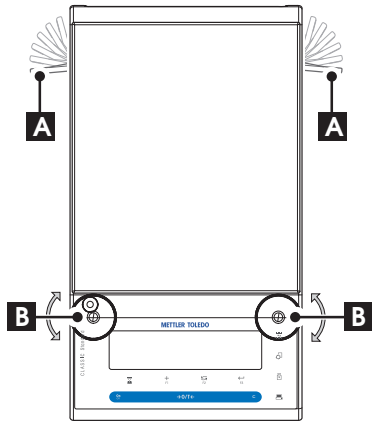

Balances with S platform and readability of 10 mg and 0.1 g

- a) Remove the clamps (A) for the safety feet by turning them outwards.
Note: Turn the clamps (A) outwards as far as they will go (~ 90°), so that the safety feet can move freely.
- b) Now level the balance by turning both leveling screws (B) until the air bubble is in the inner circle of the level indicator (see procedure above).
- c) Secure the safety feet by turning the clamps (A) inwards as far as they will go.

Balances with L platform

- Align the balance horizontally by turning the leveling screws of the balance housing until the air bubble is in the inner circle of the level indicator.

4.4 Power Supply

Your balance is supplied with an country-specific AC adapter or with a country-specific power cable. The power supply is suitable for all line voltages in the range: 100 - 240 VAC, 50/60 Hz (for exact specifications, see section "technical data").



First, check the local line voltage is in the range 100 - 240 VAC, 50/60 Hz and whether the power plug fits your local power supply connection. **If this is not the case, on no account connect the balance or the AC adapter to the power supply**, but contact the responsible METTLER TOLEDO dealer.



Important:

- Before operating, check all cables for damage.
- Guide the cables so that they cannot become damaged or interfere with the weighing process!
- Take care that the AC adapter cannot come into contact with liquids!
- The power plug must be always accessible.



Allow your balance to warm up for 30 minutes (0.1 mg models 60 minutes) to enable it to adapt itself to the ambient conditions.

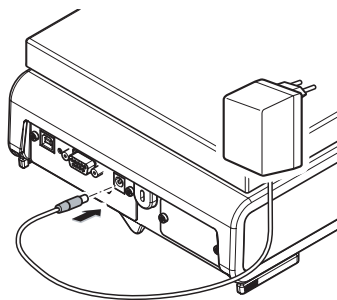

Connect the AC adapter to the connection socket on the back of your balance (see figure) and to the power line.

4.5 Battery Operation

Balances with a built-in rechargeable battery can, under normal operation conditions, work independently of the AC power line for about 8 hours. Immediately the AC power supply is interrupted e.g. by withdrawing the power cord plug or if there is a power failure, the balance switches automatically to battery operation. Once the AC power supply is restored, the balance reverts automatically to AC operation.

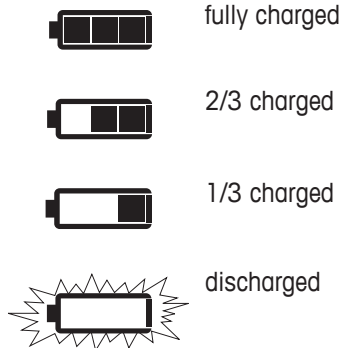

When the balance is operating on its batteries, the battery symbol in the display lights up. The number of segments that are lit is an indicator of battery condition (3 = fully charged, 0 = discharged). When the batteries are almost completely discharged, the battery symbol flashes.

Charging the built-in battery is indicated with filling up all 3 levels continuously. After the charging is finished the battery symbol is turned off. The battery is protected against overcharging, and the balance can therefore remain permanently connected with the AC power line.

Note: The built-in rechargeable battery can not be replaced by the user. Please contact METTLER TOLEDO customer Service.

4.6 Transporting the Balance

Switch off the balance and remove the power cable and any interface cable from the balance. Refer to the notes in Section "Selecting the location" regarding the choice of an optimal location.

Transporting Over Short Distances



For balances with a draft shield: Observe the following instructions to transport your balance over a short distance to a new location: **Never lift the balance by the glass draft shield. The draft shield is not sufficiently fastened to the balance.**

Transporting Over Long Distances

If you would like to transport or send your balance over long distances, **use the complete original packaging.**

4.7 Weighing Below the Balance

The balances are equipped with a hanger for carrying out weighings below the work surface (weighing below the balance).



Attention:

- **Do not place the balance on the pan support location bolt** (0.1 mg and 1 mg models).
- Models with a glass draft shield: Carefully lift the draft shield from the weighing platform and put it aside.

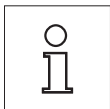

Note:

- For below-the-balance weighing with the L Platform models, you will need hook 11132565 from the accessories range.
- Weighing below the balance is not possible with "MS-KL" models.

S Platform

L Platform

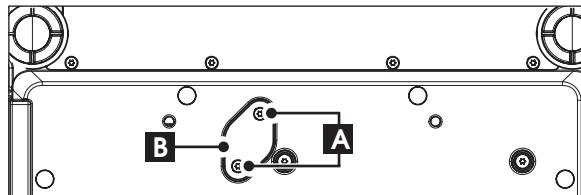
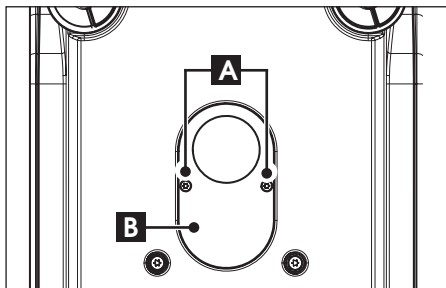

- a) Switch off the balance and remove the power cable and any interface cable from the balance.
- b) Remove the draft shield element (10 mg models).
- c) Remove the weighing pan and pan support.
- d) Remove the bottom plate and unlock the draft shield (models with draft shield).
- e) Turn the balance carefully on its side.
- f) Remove and retain the 2 screws (A) and the cover plate (B). The hanger is now accessible.
- g) Then turn the balance to its normal position and simply reinstall all components in the reverse order.

4.8 Adjustment (Calibration)



To obtain accurate weighing results,

- the balance must be adjusted to match the gravitational acceleration at its location. Adjusting is necessary:
 - before the balance is used for the first time.
 - at regular intervals during weighing service.
 - after a change of location.
- the balance must be connected to the power supply for approximately,
 - 30 minutes for balances with readability of 1 mg to 5 g
 - 60 minutes for balances with readability of 0.01 mg to 0.1 mg
 in order to reach operating temperature before adjusting.

4.8.1 Fully Automatic Adjustment FACT

Note: On models with FACT only.

The **factory setting** is fully automatic adjustment **FACT** (Fully Automatic Calibration Technology) with the internal weight (see also section "The Menu"). In this setting, you have no need worry about adjusting your balance.

The balance adjusts itself automatically:

- after the warm-up phase on connection to the power supply.
- when a change in the ambient conditions, e.g. the temperature, could lead to a noticeable deviation in the measurement.
- on a predefined time. (see menu topic "FACT")
- time interval. (with OIML accuracy class II approved models)

4.8.2 Manual Adjustment with Internal Weight

Note: On models with internal weight only (see technical data).

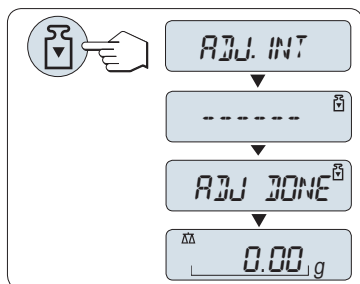

Requirement: To carry out this operation, in the menu topic "CAL" (Adjustment) of advanced menu "ADJ.INT" must be selected.

- Unload weighing pan
- Press «» to execute "Internal Adjustment".

The balance adjusts itself automatically. The adjusting is finished when the message "ADJ DONE" appears briefly on the display. The balance returns to the last active application and is ready for operation.

Sample adjustment printout using internal weight:

```

- Internal Adjustment --
21.Jan 2009      12:56

METTLER TOLEDO

Balance Type      MS4002S
SNR               1234567890

Temperature       22.5 °C
Diff              3 ppm

Adjustment done
-----

```

4.8.3 Manual Adjustment with External Weight

Note: Because of certification legislation, the approved models cannot be adjusted with an external weight * (depend on selected countries' certification legislation).

* except OIML accuracy class I approved models.

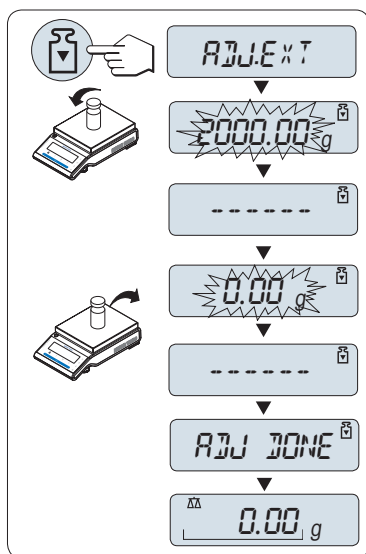

Requirement: To carry out this operation, in the menu topic "CAL" (Adjustment) of advanced menu "ADJ.EXT" must be selected.

- Have required adjustment weight ready.
- Unload weighing pan.
- Press «» briefly to execute "External Adjustment". The required (predefined) adjustment weight value flashes on the display.
- Place adjustment weight in center of pan. The balance adjusts itself automatically.
- When "0.00 g" flashes, remove adjustment weight.

The adjusting is finished when the message "ADJ DONE" appears briefly on the display. The balance returns to the last active application and is ready for operation.

Sample adjustment printout using external weight:

- External Adjustment --
21.Jan 2009 12:56

METTLER TOLEDO

Balance Type MS4002S
SNR 1234567890

Temperature 22.5 °C
Nominal 2000.00 g
Actual 1999.99 g
Diff 5 ppm

Adjustment done

Signature

.....

5 Weighing Made Simple



This section shows you how to perform simple weighings and how you can accelerate the weighing process.

5.1 Switching the Balance On and Off

This section shows you how to perform simple weighings and how you can accelerate the weighing process.

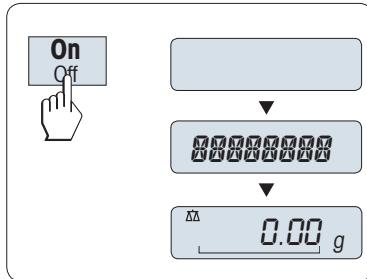

Switching On

- Remove any load from weighing pan.
- Press «On».

The balance performs a display test (all segments in the display light up briefly), "WELCOME", Software version, Maximum load and Readability appears briefly. (Startup "FULL" mode only)

The balance is ready for weighing or for operation with the last active application.

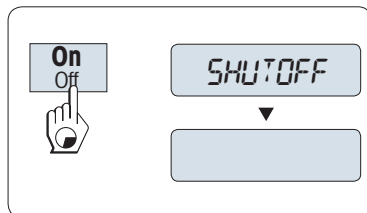

Switching Off

- Press and hold the «Off» key until "SHUTOFF" appears on the display. Release the key.

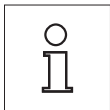

When Quickstart is selected (Advanced menu, topic "STARTUP" > "QUICK"): Once your balance has been switched off, it is in standby mode. In this case your balance needs no warm-up time in the standby mode and is immediately ready for weighing. If you wish to perform a weighing, you now only need to place the sample on the weighing pan and the balance immediately displays the result. There is no need to switch it on with the «On/Off» key.

- If your balance has been switched off after a preselected time, the display is dimly lit and shows date, time, maximum load and readability.
- If your balance has been switched off manually, the display is off.

Note:

- Quickstart is not possible with approved balances (only available in selected countries).
- Standby mode is available on line powered balances only.

5.2 Performing a Simple Weighing

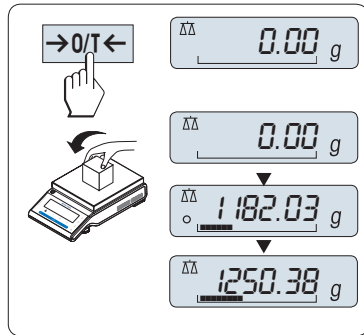

- Press «→0/T←» to zero the balance.
Note: If your balance is not in the weighing mode, press and hold the « $\Delta\Delta$ » key down until "WEIGHING" appears in the display. Release the key. Your balance is in the weighing mode and set to zero.
- Place weighing sample on the weighing pan.
- Wait until the instability detector "○" disappears and the stability beep sounds.
- Read the result.

5.3 Zero Setting / Taring

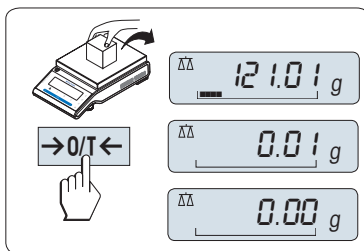

Zero setting

- Unload the balance.
- Press «→0/T←» to set the balance to zero. All weight values are measured in relation to this zero point (see menu topic "ZERO RNG").

Note: Use the «→0/T←» zeroing key before you start with a weighing.

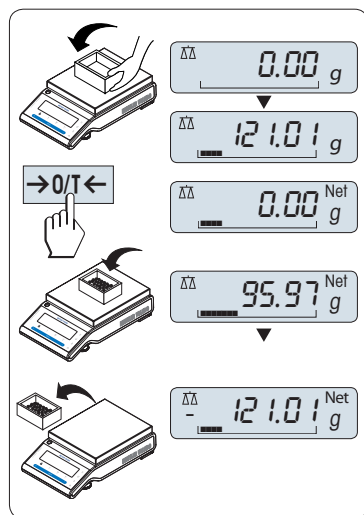

Taring

If you are working with a weighing container, first set the balance to zero.

- Place empty container on the balance. The weight is displayed.
- Press «→0/T←» to tare the balance.

"0.00 g" and "Net" appears in the display. "Net" indicates that all weight values displayed are net values.

Note:

- If the container is removed from the balance, the tare weight will be shown as a negative value.
- The tare weight remains stored until the «→0/T←» key is pressed again or the balance is switched off.
- With METTLER TOLEDO DeltaRange balances, the fine range with its 10 times smaller display increments (depending on the model) is available again after every taring operation.

5.4 METTLER TOLEDO DeltaRange Balances

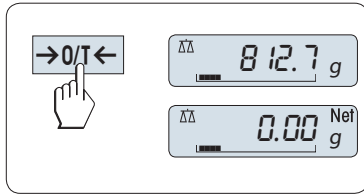

METTLER TOLEDO DeltaRange balances have a movable fine range with 10 times smaller display increments over their entire weighing range. In this fine range an additional decimal place always appears in the display.

The balance operates in the fine range

- after switching on.
- after every taring operation.

If the fine range is exceeded, the balance display automatically switches to coarser display increments.

5.5 Switching Weight Units

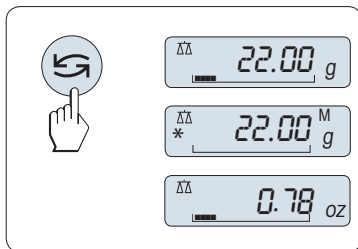

The « $\leftarrow \rightleftarrows \rightarrow$ » key can be used at any time to toggle between weight unit "UNIT 1", "RECALL" value (if selected) and weight unit "UNIT 2" (if different from weight unit 1) and the application unit (if any).

5.6 Recall / Recall Weight Value

Recall stores stable weights with an absolute display value bigger than 10d.

Requirement: The function "RECALL" must be activated in the menu.

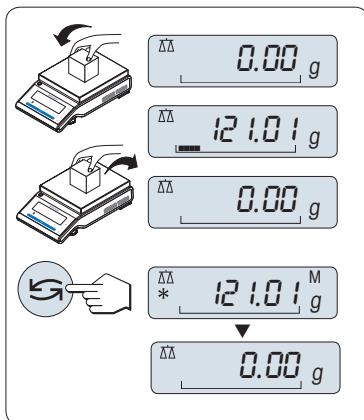

- Load weighing sample. The display shows weight value and stores stable value.
- Remove weighing sample. When the weight is removed the Display shows zero.
- Press « $\leftarrow \rightleftarrows \rightarrow$ ». The display shows last stored stable weight value for 5 seconds together with asterisk (*) and Memory (M) symbols. After 5 seconds the display goes back to zero. This can be repeated unlimited times.

Delete last weight value

As soon a new stable weight value is displayed, the old recall value becomes replaced by the new weight value. When pressing « $\rightarrow 0/T \leftarrow$ », the recall value is set to 0.

Note: If the power is switched off, the recall value is lost. The recall value can not be printed.

5.7 Weighing with the Weighing-in Aid



The weighing-in aid is a dynamic graphic indicator which shows the used amount of the total weighing range. You can thus recognize at a glance when the load on the balance approaches the maximum load.

5.8 Print / Transmit Data

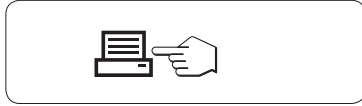

Pressing the «» key transmits the weighing results over the interface e.g. to a printer or a PC.

6 The Menu

6.1 What is in the Menu ?



The Menu allows you to match your balance to your specific weighing needs. In the menu you can change the settings of your balance and activate functions. The main menu has 4 different menus and these contains 45 different **topics**, each of which allows you various **selection** possibilities. For Menu "PROTECT" see chapter "Description of menu topics" section "Main menu".

Note: See Quick Guide for the graphical overview of the menu (Menu Map) with all setting possibilities.

Menu "BASIC"

Topic	Description
DATE	Setting the current date.
TIME	Setting the current time.
UNIT 1	Specification of the 1 st weight unit in which the balance should show the result.
UNIT 2	Specification of the 2 nd weight unit in which the balance should show the result.
KEY BEEP	Setting the key beep level.
STAB.BEEP	Setting the stability beep level.
RESET	Call up of the factory settings.

Menu "ADVANCED"

Topic	Description
ENVIRON.	Matching the balance to the ambient conditions.
CAL	Settings for the type of adjustment (calibration).
FACT	Settings for fully automatic balance adjustment based on a selected time.
FACT PRT.	Switching the automatic FACT printout on or off.
DATE.FORM	Setting the date format.
TIME.FORM	Preselection of the time format.
RECALL	Switching the application "Recall" for storing stable weights on or off.
STARTUP	Setting the mode which the balance powers up ("FULL" or "QUICK").
SHUTOFF	Setting the time after which the balance should be switched off automatically.
BCKLIGHT	Setting the time after which the display backlight should be switched off automatically.
DISPLAY	Adjusting the brightness and contrast of the display.
AUTOZERO	Switching the automatic zero correction (Autozero) on or off.
ZERO RNG	Setting the zero limit of the zero/tare key.
LANGUAGE	Setting the preferred language.
ASSIGN:F1	Selection of assigned F1 key application and entering their parameter settings.
ASSIGN:F2	Selection of assigned F2 key application and entering their parameter settings.
ASSIGN:F3	Selection of assigned F3 key application and entering their parameter settings.
DIAGNOSE	Starting a diagnostic application.
SERV.ICON	Switching the service icon (service reminder) on or off.
SRV.D.RST	Reset service date and hours (service reminder).

Menu "INT.FACE"

Topic	Description
RS232	Matching the serial interface RS232C to a peripheral unit.
HEADER	Setting the header for printout of individual values.
SINGLE	Setting the information for printout of individual values.
SIGN.L	Setting the footer for printout of individual values.
LINE.FEED	Setting line feed for printout of individual values.
ZERO PRT.	Setting the auto print function for printing zero.
COM.SET	Setting the data communication format of the serial interface RS232C.
BAUDRATE	Setting the transfer speed of the serial interface RS232C.



Topic	Description
BIT/PAR.	Setting the character format (Bit/Parity) of the serial interface RS232C.
STOPBIT	Setting the character format (stop bit) of the serial interface RS232C.
HD.SHAKE	Setting the transfer protocol (Handshake) of the serial interface RS232C.
RS E.O.L.	Setting the end of line format of the serial interface RS232C.
RS CHAR	Setting the char set of the serial interface RS232C.
USB	Matching the USB interface to a peripheral unit. (Not available with MSxxxKLIPE models)
USB COM.S.	Setting the data communication format of the USB interface. (Not available with MSxxxKLIPE models)
USB E.O.L.	Setting the end of line format of the USB interface. (Not available with MSxxxKLIPE models)
USB CHAR	Setting the char set of the USB interface. (Not available with MSxxxKLIPE models)
INTERVAL	Selection of the time interval for the simulated print key press.

6.2 Menu Operation

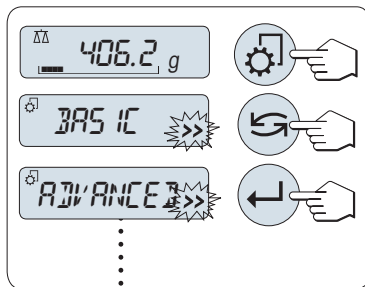
In this Section you will learn how to work with the menu.





Select Menu

- Press «» to activate main menu. The first menu "BASIC" is displayed (except menu protection is active).
- Press «» repeatedly to change menu (Scrolling down/up «+» / «-» keys).
- Press «» to confirm the selection.

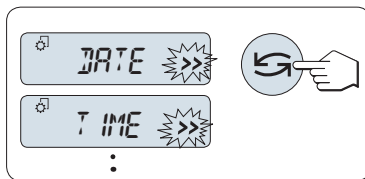
Note: The menu selection "BASIC", "ADVANCED" or "INT.FACE" can not be saved. The selection "PROTECT" must be saved.



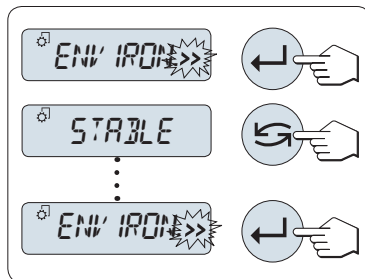

Select Menu Topic

- Press «». The next menu topic appears in the display. Each time the «» or the «+» key is pressed, the balance switches to the next menu topic; the «-» key to the previous menu topic.

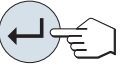

Change Settings in a Selected Menu Topic

The ">>" flashing symbol in the display indicates selectable options available.

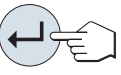
- Press «». The display shows the current setting in the selected menu topic. Each time «» or «+» is pressed, the balance switches to the next selection; press «-» to the previous selection. After the last selection, the first is shown again.
- Press «», the selected setting is accepted but not yet executed. The settings are executed only after "SAVE:YES" has been confirmed.

Change Settings in a Submenu Selection

The same procedure as for menu topics.

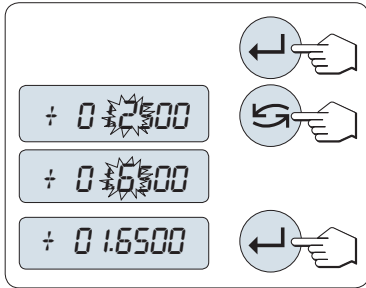

Input Principle of Numerical Values

- Press «←» for input of numerical values.
- Press «→» to select a digit or a value (depending on the application). The selected digit or the selected value is blinking.
- For changing digits or values, press «+» to scroll up or «-» to scroll down.
- Press «←» to confirm the input.

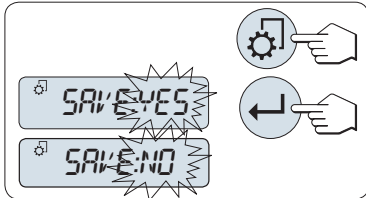

Saving Settings and Closing the Menu

- Press «⚙» briefly to leave menu topic.
- Press «←» to execute "SAVE:YES". Changes are saved.
- Press «←» to execute "SAVE:NO". Changes are not saved. To toggle between "SAVE:YES" and "SAVE:NO" press «↺».



Cancel

- For leaving menu topic or menu selection without saving press «C» (one step back in the menu).

Note: If no entry is made within 30 seconds, the balance reverts to last active application mode. Changes are not saved. If changes are made, the balance asks "SAVE:NO".

6.3 Description of Menu Topics

In this Section you will find information regarding the individual menu topics and the available selections.

6.3.1 Main Menu

Selecting the menu.

"BASIC"	The small "BASIC" menu for simple weighing is displayed.
"ADVANCED"	The extended "ADVANCED" menu for further weighing settings is displayed.
"INT.FACE"	The menu "INT.FACE" for all interface parameter settings for peripheral devices e.g. printer is displayed.
"PROTECT"	Menu protection. Protection of balance configurations against unmeant manipulation.
"OFF"	Menu protection is off. (Factory setting)
"ON"	Menu protection is on. The menu BASIC, ADVANCED and INT.FACE are not displayed. This is indicated with "🔒" in the display.

Note:

- The menu selection "BASIC", "ADVANCED" or "INT.FACE" can not be saved.
- To activate "PROTECT" "ON" or "OFF", this selection must be saved.

6.3.2 Basic Menu

"DATE" – Date

Setting the current date according to date format.

Note: A reset of the balance will not change this setting.

"TIME" – Time

Setting the current time according to time format

" +1H"	Set the current time forwards by 1 hour (to adjust summer or winter time). (Factory setting)
" -1H"	Set the current time backwards by 1 hour (to adjust summer or winter time).
"SET TIME"	Enter the current time.

Note: A reset of the balance will not change this setting.

"UNIT 1" – Weight Unit 1

Depending on requirements, the balance can operate with the following units (depending on the model)

- Only those weight units allowed by the appropriate national legislation are selectable.
- With approved balances, this menu topic has a fixed setting and cannot be changed.
- Conversion table for weight units see chapter Appendix.

Units:

g ¹⁾	Gram	dwt	Pennyweight
kg ²⁾	Kilogram	mom	Momme
mg ³⁾	Milligram	msg	Mesghal
ct	Carat	tlh	Tael Hong Kong
lb	Pound	tis ⁴⁾	Tael Singapore
oz	Ounce (avdp)	tlt	Tael Taiwan
ozt	Ounce (troy)	tola	Tola
GN	Grain	baht	Baht

¹⁾ factory setting

²⁾ not with 0.01 mg, 0.1 mg and 1 mg balances

³⁾ with 0.01 mg, 0.1 mg and 1 mg balances

⁴⁾ the Malaysian tael has the same value

"UNIT 2" – Weight Unit 2

If it is required to show the weighing results in weighing mode in an additional unit, the desired second weight unit can be selected in this menu topic (depending on the model). Units see "UNIT 1". Select "NO", if you do not want to use "UNIT 2".

Note: Only those weight units allowed by the appropriate national legislation are selectable.

"KEY BEEP" – Key Beep

This menu topic allows you to select the volume of the key beep. The according key beep is emitted during the setting.

"MED"	Medium level (Factory setting)
"HIGH"	High level
"OFF"	Beep switched off
"LOW"	Low level

"STAB.BEEP" – Stability Beep

If the unstable symbol disappears, the stability beep becomes active. This menu topic allows you to preselect the volume of the stability beep.

"LOW"	Low level (Factory setting)
"MED"	Medium level
"HIGH"	High level
"OFF"	Beep switched off

"RESET" – Reset Balance Settings

This menu topic allows you to cal-up the factory settings.

To toggle between "YES?" and "NO?" press «» (or «+» or «-»).

Note: A reset of the balance will not change the "DATE", "TIME" and "ZERO RNG" settings.



6.3.3 Advanced Menu

"ENVIRON." – Environment Settings

This setting can be used to match your balance to the ambient conditions.

"STANDARD"	Setting for an average working environment subject to moderate variations in the ambient conditions. (Factory setting)
"UNSTABLE"	Setting for a working environment where the conditions are continuously changing.
"STABLE"	Setting for a working environment which is practically free from drafts and vibrations.

"CAL" – Adjustment (calibration)

In this menu topic you can preselect the function of the «» key. Your balance can be adjusted with internal or external weights by pressing the «» key. If you have attached a printer to your balance, the data of the adjustment (calibration) are printed out.

"ADJ.OFF"	The adjustment is switched off . The «  » key has no function.
"ADJ.INT"	Internal adjustment: adjustment is performed at a keystroke with the built-in weight (depending on the model, see technical data).
"ADJ.EXT"	External adjustment: adjustment is performed at a keystroke with a selectable external weight. Note: This function is not available for approved balances * (depend on selected countries' certification legislation). * except OIML accuracy class I approved models.
"200.00 g"	Defining the external adjustment weight: define the weight of the external adjustment weight (in grams). Factory setting: depends on the model.

"FACT" – Fully Automatic Adjustment

Fully automatic internal adjustment (calibration) **FACT** (Fully Automatic Calibration Technology) provides fully automatic balance adjustment based on temperature criteria and on preselected time. (depending on the model, see technical data)

"TIME"	Execute FACT (with selected time).
"12:00"	Specify the time for a fully automatic adjustment to take place every day. Factory setting: 12:00 (according to time format)
"OFF"	FACT is switched off .

"FACT.PRT." – Protocol Trigger for Fact

This setting specifies whether an adjustment report should be printed automatically.

Note: This menu topic does not affect the printing of adjustments with an internal or external adjustment weight.

"OFF"	Protocol switched off: if the balance adjusts automatically (FACT), a protocol is not printed out.
"ON"	Protocol switched on: a record is printed out after every automatic adjustment of the balance (FACT).

Note: The protocol is printed out without a line for signatures.

"DATE.FORM" – Date Format

This menu topic allows you to preselect the date format.

The following date formats are available:

	Display examples	Printing examples
"DD.MM.Y"	01.02.2009	01 . 02 . 2009
"MM/DD/Y"	02/01/09	02 / 01 / 2009
"Y-MM-DD"	09-02-01	2009-02-01
"D.MMM Y"	1.FEB.09	1 . FEB 2009
"MMM D Y"	FEB.1.09	FEB 1 2009

Factory setting: "DD.MM.Y"

"TIME.FORM" – Time Format

This menu topic allows you to preselect the time format.

The following date formats are available:

	Display examples
"24:MM"	15:04
"12:MM"	3:04 PM
"24.MM"	15.04
"12.MM"	3.04 PM

Factory setting: "24:MM"

"RECALL" – Recall

This menu topic allows you to switch the "RECALL" function on or off. When it is switched on recall stores the last stable weight if the absolute display value was bigger than 10d.

"OFF"	"RECALL" switched off (Factory setting)
"ON"	"RECALL" switched on

Note: The recall value is displayed with an asterisk and cannot be printed.

"STARTUP" – Startup Mode

You can set your balance such that it either immediately starts from the standby mode when you load a weight or it must be switched on with the «ON/OFF» key after which it then performs a display test.

Note: This topic is not visible with approved balances (only available in selected countries).

"QUICK"	"Quickstart": The balance can be started directly from the standby mode and is immediately ready for weighing. You can load the weight in the standby mode and the balance immediately shows the current weighing result. This is the Factory setting
---------	---

Note: Standby mode is available on line powered balances only.

"FULL"

Start with display test: You must switch on the balance with the «ON/OFF» key. After it has been switched on, it performs a display test for approx. 2 sec. in which all display elements lights up, it shows "WELCOME", software version, maximum load and readability. The balance is ready for weighing.

"SHUTOFF" – Automatic Shutoff

If the automatic shutoff function is activated, the balance automatically switches itself off after a preselected time of inactivity (i.e. with no key being pressed or changes of weight occurring etc.) and is switched to the standby mode.

"A.OFF 10" min	Automatic shutoff after 10 minutes of inactivity. (Factory setting)
"A.OFF –"	Automatic shutoff not activated.
"A.OFF 2" min	Automatic shutoff after 2 minutes of inactivity.
"A.OFF 5" min	Automatic shutoff after 5 minutes of inactivity.

"BCKLIGHT" – Backlight

Under this menu topic, the display backlight can be switched off automatically. If the automatic switch-off is activated, the backlight will turn off automatically after the selected period of inactivity has elapsed. The backlight is reactivated when a key is pressed or the weight is changed.

"B.L. ON"	Backlight is always on . (Factory setting)
"B.L. 30" s	Automatic switch-off after 30 seconds inactivity.
"B.L. 1" min	Automatic switch-off after 1 minute inactivity.
"B.L. 2" min	Automatic switch-off after 2 minutes inactivity.
"B.L. 5" min	Automatic switch-off after 5 minutes inactivity.

"DISPLAY" – Display Settings

This menu topic allows you to adjust brightness and contrast of the display.

"BRIGHTN"	To set the brightness in 1% steps.
"50%"	Factory setting: 50%
"CONTRAST"	To set the contrast in 1% steps.
"75%"	Factory setting: 75%

"AUTOZERO" – Automatic Zero Setting

This menu topic allows you to switch the automatic zero setting on or off.

"ON"	"AUTOZERO" switched on (Factory setting). The automatic zero setting continuously corrects possible variations in the zero point that might be caused through small amounts of contamination on the weighing pan.
"OFF"	"AUTOZERO" switched off . The zero point is not automatically corrected. This setting is advantageous for special applications (e.g. evaporation measurements).

Note: With approved balances, this setting is not available (only available in selected countries).

"ZERO RNG" – Zero Range

This menu topic allows you to set a zero limit for the «→0/T←» key. Up to and including this limit the «→0/T←» key will execute a zero. Above this limit the «→0/T←» key will execute a tare.

"21g"

To set the upper limit of the zero setting range as weight in the definition unit of the balance.

(**Factory setting:** 0.5% of weighing range)

Note: With approved balances, this setting is not available and fixed to 3e (only available in selected countries).

Note: A reset of the balance will not change this setting.

"LANGUAGE" – Language

Factory setting: Generally, the language of the destination country (if available) or English is set.

The following languages are available (depending on the language package installed):

"ENGLISH"	English	"POLSKI"	Polish
"DEUTSCH"	German	"CESKY"	Czech
"FRANCAIS"	French	"MAGYAR"	Hungarian
"ESPANOL"	Spanish	"NEDERL."	Dutch
"ITALIANO"	Italian	"BR.PORTUG."	Brasil Portuguese
"RUSSIAN"	Russian		

"ASSIGN:F1" – Assign Application Key F1

At this menu topic you can assign an application to the «**F1**» key. The following applications are available (depending on the model):

"COUNTING"	Piece counting (Factory setting)
"PERCENT"	Percent weighing
"CHECK"	Checkweighing
"STAT"	Statistics
"FORMULA"	Formulation / Net-Total
"TOTALING"	Totaling
"DYNAMIC"	Dynamic weighing
"FACTOR M"	Multiplication factor
"FACTOR D"	Division factor
"DENSITY"	Density

"ASSIGN:F2" – Assign Application Key F2

At this menu topic you can assign an application to the «**F2**» key. The following applications are available (depending on the model):

"PERCENT"	Percent weighing (Factory setting)
"CHECK"	Checkweighing
"STAT"	Statistics
"FORMULA"	Formulation / Net-Total
"TOTALING"	Totaling
"DYNAMIC"	Dynamic weighing
"FACTOR M"	Multiplication factor
"FACTOR D"	Division factor
"DENSITY"	Density
"COUNTING"	Piece counting

"ASSIGN:F3" – Assign Application Key F3

At this menu topic you can assign an application to the «F3» key. The following applications are available (depending on the model):

"CHECK"	Checkweighing (Factory setting)
"STAT"	Statistics
"FORMULA"	Formulation / Net-Total
"TOTALING"	Totaling
"DYNAMIC"	Dynamic weighing
"FACTOR M"	Multiplication factor
"FACTOR D"	Division factor
"DENSITY"	Density
"R. TEST"	Routine test
"COUNTING"	Piece counting
"PERCENT"	Percent weighing

"DIAGNOSE" – Diagnostics Application

At this menu topic you can start a diagnostic application. For more information see chapter application "Diagnostics".

The following diagnostics are available:

"REPEAT.T"	Repeatability test (models with internal weights only)
"DISPLAY"	Display test
"KEYPAD T"	Key test
"CAL.MOT. T"	Motor test (models with internal weights only)
"BAL.HIST"	Balance history
"CAL.HIST"	Calibration history
"BAL.INFO"	Balance information
"PROVIDER"	Service provider information

"SERV.ICON" – Service Reminder

This menu topic allows you to switch the service reminder "🔧" on or off.

"ON"	Service reminder "🔧" switched on (factory setting). You will be informed after a preset time (e.g. one Year or 8000 operating hours) to call service for recalibration. This will be indicated by the flashing service icon: "🔧". (Factory setting)
"OFF"	Service reminder "🔧" switched off .

"SRV.D.RST" – Service Date Reset

This menu topic allows you to reset service date and hours.

Note: This menu topic is only available if "SERV.ICON" setting "ON" was selected.











To toggle between "YES?" and "NO?" press «» (or «+» or «-»)

6.3.4 Interface Menu

"RS232" – RS232C Interface ¹⁾

At this menu topic you can select the peripheral device connected to the RS232C interface and specify how the data is transmitted.

"PRINTER"	Connection to a printer . (Factory setting) Note: Only one printer possible.
-----------	--

"PRT.STAB"	If the «  » key is pressed, the next stable weight value will be printed. (Factory setting)
"PRT.AUTO"	Every stable weight value will be printed, without pressing the «  » key.
"PRT.ALL"	If the «  » key is pressed, the weight value will be printed regardless of stability.
"PC-DIR."	Connection to a PC : the balance can send data (as a Keyboard) to the PC used for PC applications e.g. Excel. Note: The balance sends the weight value without the unit to the PC.
"PRT.STAB"	If the «  » key is pressed, the next stable weight value will be sent followed by an enter. (Factory setting)
"PRT.AUTO"	Every stable weight value will be sent followed by an enter, without pressing the «  » key.
"PRT.ALL"	If the «  » key is pressed, the weight value will be sent followed by an enter regardless of stability.
"HOST"	Connection to a PC , Barcode Reader etc.: the balance can send data to the PC and receive commands or data from the PC).
"SEND.OFF"	Send mode switched off. (Factory setting)
"SEND.STB"	If the «  » key is pressed, the next stable weight value will be sent.
"SEND.CONT"	All weight value updates will be sent regardless of stability, without pressing the «  » key.
"SEND.AUTO"	Every stable weight value will be sent, without pressing the «  » key.
"SEND.ALL"	If the «  » key is pressed, the weight value will be sent regardless of stability.
"2.DISPLAY"	Connection of an optional auxiliary display unit Note: The transmission parameters cannot be selected. Settings are automatically set.



Attention:

- If you select 2nd Display "2.DISPLAY", first make sure that no other device is connected at COM1 as a 2nd display. Other devices could be damaged because of the voltage on connector Pin 9. Necessary for powering the 2nd display (see chapter "Interface Specification")

"HEADER" – Options for the Printout Header of individual values

This menu topic allows you to specify the information that is to be printed at the top of the printout for every individual weighing results (after pressing «»).

Note: This menu topic is only available if "PRINTER" setting was selected.

"NO"	The header is not be printed (Factory setting)
"DAT / TIM"	Date and time are printed
"D / T / BAL"	Date, time and balance information (Balance type, SNR, Balance ID) are printed.

Note: Balance ID only if set.

"SINGLE" – Options for Printing out the Result of individual values

This menu topic allows you to specify the information that is to be printed for every individual weighing result (after pressing «»).

Note: This menu topic is only available if "PRINTER" setting was selected.

"NET"	The value of the Net weight from the current weighing is printed (Factory setting)
"G / T / N"	The values of the Gross weight, the Tare weight and the Net weight are printed

"SIGN.L" – Options for the Printout Footer for Signature Line of individual values

This menu topic allows you to set a footer for signature at the bottom of the printout for every individual weighing result (after pressing «»).

Note: This menu topic is only available if "PRINTER" setting was selected.

"OFF"	The signature footer is not be printed. (Factory setting)
"ON"	The signature footer is printed

"LINE.FEED" – Options for Complete the Printout of individual values

This menu topic allows you to specify the number of blank lines to complete the printout (line feed) for every individual weighing result (after pressing «»).

Note: This menu topic is only available if "PRINTER" setting was selected.

"0"	Possible numbers of blank lines: 0 to 99 (Factory setting = 0)
-----	---

"ZERO PRT." – Options for "PRT.AUTO" ¹⁾

This menu topic allows you to specify the auto print function "PRT.AUTO" for printing zero "YES" or "NO".

"OFF"	Zero is not be printed (Zero +/- 3d) (Factory setting)
"ON"	Zero is always printed

Note: This menu topic is only available if "PRT.AUTO" fuction of the "PRINTER" or "PC-DIR." was selected.

"COM.SET" – Options for the Data Communication Format (RS232C)("HOST") ¹⁾

This menu topic allows you to set the data format depending on which peripheral device is connected.

Note: This menu topic is only available if "HOST" setting was selected.

"MT-SICS"	The MT-SICS data transfer formats is used. (Factory setting) For more information see section "MT-SICS Interface Commands and Functions".
"MT-PM"	The following PM balance commands are supported: S Send value SI Send immediate value SIR Send immediate value and repeat SR Send value and repeat SNR Send next value and repeat T Tare TI Tare immediately B Base (Negative values are limited up to the current tare values) MI Modify ambient vibration MZ Modify Auto Zero M Modified settings reset ID Identify CA Calibrate

D	Display (only symbol N and G available)
"SART"	The following Sartorius commands are supported:
K	Ambient conditions: very stable
L	Ambient conditions: stable
M	Ambient conditions: unstable
N	Ambient conditions: very unstable
O	Block keys
P	Print key (print, auto print; activate or block)
Q	Acoustic signal
R	Unblock keys
S	Restart/self-test
T	Tare key
W	Calibration/adjustment (depending on the menu setting *)
Z	Internal calibration/adjustment **)
f0_	Function key (F)
f1_	Function key (CAL)
s3_	C key
x0_	Perform internal calibration **)
x1_	Print balance/scale model
x2_	Print weighing cell serial number
x3_	Print software version

*) may be inaccessible on verified balances/scales
 **) only on models with built-in motorized calibration weight

Functionality mapping

"HOST" settings:	Sartorius printer settings:
"SEND.OFF"	not applicable
"SEND.STB"	manually print with stability
"SEND.ALL"	manually print without stability
"SEND.CONT"	automatically print without stability
"SEND.AUTO"	similar applicable to automatically print when load is changed

"BAUDRATE" – Baud rate RS232C ¹⁾

This menu topic allows you to match the data transmission to different serial RS232C receivers. The baud rate (data transfer rate) determines the speed of transmission via the serial interface. For problem-free data transmission the sending and receiving devices must be set at the same value.

The following settings are available:

600 bd, 1200 bd, 2400 bd, 4800 bd, 9600 bd, 19200 and 38400 bd. (default: **9600 bd**)

Note:

- Not visible for 2nd display.
- Each device has separate settings.

"BIT/PAR." – Bit/Parity RS232C ¹⁾

At this menu topic you can set the character format for the attached RS232C serial peripheral device.

"8/NO"	8 data bits/no parity (Factory setting)
"7/NO"	7 data bits/no parity

"7/MARK"	7 data bits/mark parity
"7/SPACE"	7 data bits/space parity
"7/EVEN"	7 data bits/even parity
"7/ODD"	7 data bits/odd parity

Note:

- Not visible for 2nd display.
- Each device has separate settings.

"STOPBIT" – Stop Bits RS232C ¹⁾

At this menu topic you can set the stop bits of the transmitted data to different RS232C serial receivers.

"1 BIT"	1 Stop bit (Factory setting)
"2 BITS"	2 Stop bits

Note:

- Not visible for 2nd display.
- Each device has separate settings.

"HD.SHAKE" – Handshake RS232C ¹⁾

This menu topic allows you to match the data transmission to different RS232C serial receivers.

"XON/XOFF"	Software handshake (XON/XOFF) (Factory setting)
"RTS/CTS"	Hardware handshake (RTS/CTS)
"OFF"	No handshake

Note:

- Not visible for 2nd display.
- Each device has separate settings.

"RS E.O.L." – End of Line RS232C ¹⁾

At this menu topic you can set the "End of Line" character of the transmitted data to different RS232C serial receivers.

"(CR)(LF)"	<CR><LF> Carriage Return followed by Line feed (ASCII-Codes 013+010) (Factory setting)
"(CR)"	<CR> Carriage Return (ASCII-Code 013)
"(LF)"	<LF> Line feed (ASCII-Code 010)

Note:

- Not visible for 2nd display.
- Each device has separate settings.

"RS CHAR" – Char Set RS232C ¹⁾

At this menu topic you can set the "Character Set" of the transmitted data to different RS232C serial receivers.





"IBM/DOS"	Char Set IBM/DOS (Factory setting)
"ANSI/WIN"	Char Set ANSI/WINDOWS

Note:

- Not visible for 2nd display.
- Each device has separate settings.

"USB" – USB Interface

At this menu topic you can select the mode of the "USB Device" interface and specify how the data is transmitted.

"USB"	Select the mode of the "USB Device" interface
"SEND.OFF"	Send mode switched off (Factory setting)
"SEND.STB"	If the «  » key is pressed, the next stable weight value will be sent.
"SEND.CONT"	All weight value updates will be sent regardless of stability, without pressing the «  » key.
"SEND.AUTO"	Every stable weight value will be sent, without pressing the «  » key.
"SEND.ALL"	If the «  » key is pressed, the weight value will be sent regardless of stability.

Note: This port is not usable for printers or displays.

Note: This menu topic is not available with MSxxxKLIPE models.

"USB COM.S." – Options for the Data Communication Format (USB)

This menu topic allows you to set the data format depending on which peripheral device is connected.

"MT-SICS"	The MT-SICS data transfer format is used. (Factory setting) For more information see section "MT-SICS Interface Commands and Functions".
"MT-PM"	The following PM balance commands are supported: S Send value SI Send immediate value SIR Send immediate value and repeat SR Send value and repeat SNR Send next value and repeat T Tare TI Tare immediately B Base (Negative values are limited up to the current tare values) MI Modify ambient vibration MZ Modify Auto Zero M Modified settings reset ID Identify CA Calibrate D Display (only symbol N and G available)
"SART"	The following Sartorius commands are supported: K Ambient conditions: very stable L Ambient conditions: stable M Ambient conditions: unstable N Ambient conditions: very unstable O Block keys P Print key (print, auto print; activate or block) Q Acoustic signal R Unblock keys S Restart/self-test

T	Tare key
W	Calibration/adjustment (depending on the menu setting *)
Z	Internal calibration/adjustment **)
f0_	Function key (F)
f1_	Function key (CAL)
s3_	C key
x0_	Perform internal calibration **)
x1_	Print balance/scale model
x2_	Print weighing cell serial number
x3_	Print software version

*) may be inaccessible on verified balances/scales

**) only on models with built-in motorized calibration weight

Functionality mapping

"HOST" settings:	Sartorius printer settings:
"SEND.OFF"	not applicable
"SEND.STB"	manually print with stability
"SEND.ALL"	manually print without stability
"SEND.CONT"	automatically print without stability
"SEND.AUTO"	similar applicable to automatically print when load is changed

Note: This menu topic is not available with MSxxxKLIPE models.

"USB E.O.L." – End of Line USB

At this menu topic you can set the "End of Line" character of the transmitted data to USB device.

"(CR)(LF)"	<CR><LF> Carriage Return followed by Line feed (ASCII-Codes 013+010) (Factory setting)
"(CR)"	<CR> Carriage Return (ASCII-Code 013)
"(LF)"	<LF> Line feed (ASCII-Code 010)

Note: This menu topic is not available with MSxxxKLIPE models.

"USB CHAR" – Char Set USB

At this menu topic you can set the "Character Set" of the transmitted data to USB device.

"ANSI/WIN"	Char Set ANSI/WINDOWS (Factory setting)
"IBM/DOS"	Char Set IBM/DOS

Note: This menu topic is not available with MSxxxKLIPE models.

"INTERVAL" – Print Key Simulation

At this menu topic you can activate a simulation of the «» key. "INTERVAL" simulates a print key press every x seconds.

Range:	0 to 65535 seconds
0 sec:	disables the print key simulation

Factory setting: 0 sec

Note: The executed action is according to the configuration of the print key. (see interface setting)

1) Note for 2nd RS232C Interface

- If an optional 2nd interface is installed, the menu topic is displayed for each interface, e.g
"BAUDRATE.1" for standard interface
"BAUDRATE.2" for optional 2nd interface
 - Only one printer can be set if two RS232 interfaces are existing.
-

7 Application "Piece Counting"

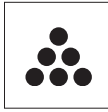

The "**Piece Counting**" application allows you to determine the number of pieces put on the weighing pan.

Requirement: The function "COUNTING" must be assigned to an «Fx» key (see advanced menu topic "ASSIGN:Fx", factory setting: F1).



- Activate function "COUNTING" by pressing and holding the appropriate assigned «Fx» key (factory setting: F1).

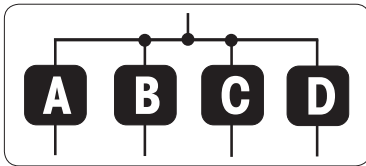

Piece Counting first requires the setting of a reference weight, there are 4 possibilities:

- A** Setting the reference **by multiple pieces with fix reference values.**
- B** Setting the reference **by multiple pieces with variable reference values.**
- C** Setting the reference **for 1 piece in weighing mode.**
- D** Setting the reference **for 1 piece in manual mode.**

Setting possibility

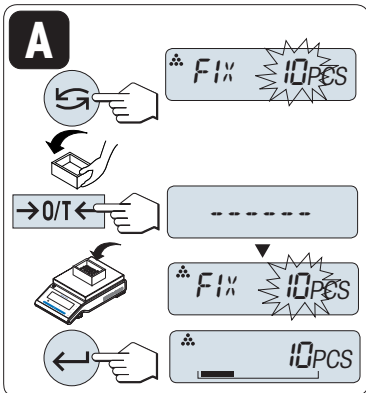

A **Setting the reference by multiple pieces with fix reference values**

- a) Select a number of reference pieces by scrolling with «». Possible numbers* are 5, 10, 20 and 50.
* with approved balances in selected countries: min 10
- b) Press «» to tare. If using: place empty container on the weighing pan first or tare again.
- c) Add the selected number of reference pieces to container.
- d) Press «» to confirm.

Setting possibility

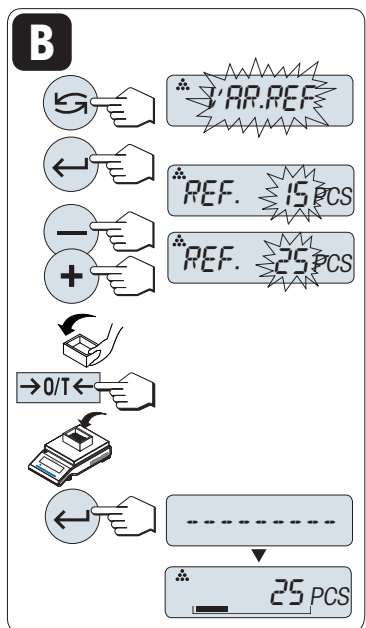

B **Setting the reference by multiple pieces with variable reference values**

- a) Select "VAR.REF" by scrolling with «». Press «» to confirm.
- b) Select a number of reference pieces by scrolling up («+» key) or down («-» key). Speed up by press and hold. Possible numbers* are 1 to 999.
* with approved balances in selected countries: min 10
- c) Press «» to tare. If using: place empty container on the weighing pan first or tare again.
- d) Add the selected number of reference pieces to container.
- e) Press «» to confirm.

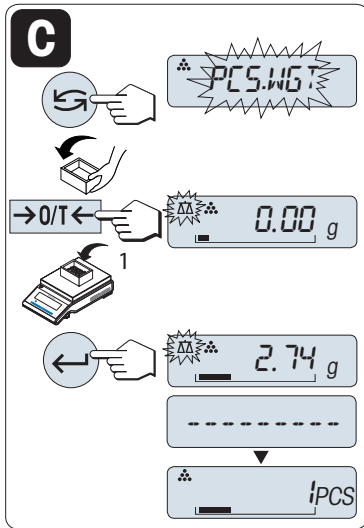

Setting possibility

C Setting the reference for one piece in weighing mode

- Select "PCS.WGT" by scrolling with «←→».
- Press «→0/T←» to tare. If using: place empty container on the weighing pan first or tare again.
- Add one reference piece to container. The weight of one piece is displayed.
- Press «←→» to confirm.

Note: With approved balances, this setting is not available in selected countries.

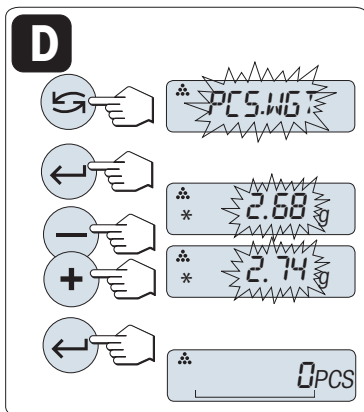

Setting possibility

D Setting the reference for one piece in manual mode

- Select "PCS.WGT" by scrolling with «←→».
- Press «←→» to confirm.
- Enter the final reference one piece weight by scrolling up («+» key) or down («-» key). Speed up by press and hold.
- Press «←→» to confirm.

Note: With approved balances, this setting is not available in selected countries.

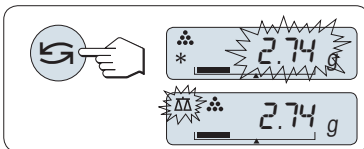

Switching between manual mode and weighing mode

- Press «←→» to switch between manual and weighing mode.

Note: By switching from weighing mode to manual mode the weight value will be transferred and can be changed manually.

Note: If without any key press within 60 seconds, the balance returns to the previous active application. Press «C» to cancel and returns to the previous active application.

On completion of the setting procedure, your balance is ready for piece counting.

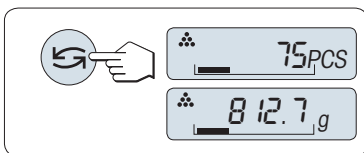

Switching between piece count and weight display.

You can use the «←→» key at any time to switch the display between piece display, weighing unit "UNIT 1", "RECALL" value (if activated) and weighing unit "UNIT 2" (if different from "UNIT 1").

Note:

- The "RECALL" value is displayed with an asterisk (*) and icon "M" and can not be printed.
- Take into account minimum values: min. reference weight = 10d (10 digits), min. piece weight* = 1d (1 digit)!
* with approved balances in selected countries: min 3e
- The current reference weight remains stored until the reference setting is changed.

8 Application "Percent Weighing"



The "Percent Weighing" application allows you to check a sample weight as percentage to a reference target weight.

Requirement: The function "PERCENT" must be assigned to an «Fx» key (see advanced menu topic "ASSIGN:Fx", factory setting: F2).



- Activate function percent weighing "PERCENT" by pressing and holding the appropriate assigned «Fx» key (factory setting: F2).

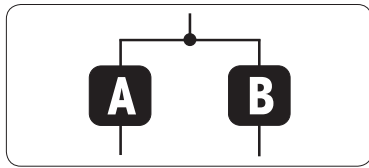

Percent Weighing first requires the setting of a reference weight that should corresponds to 100%, there are 2 possibilities:

- A** Setting the reference in manual mode (enter 100%).
- B** Setting the reference in weighing mode (weigh 100%).

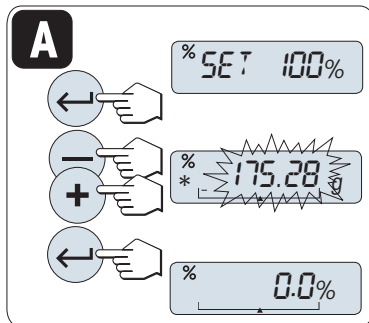

Setting possibility

A Setting the reference by manual mode (enter 100%)

- a) Press «←» to activate manual mode.
- b) Select the reference target weight (100%) by scrolling up («+» key) or down («-» key). Speed up by press and hold.
- c) Press «←» to confirm.

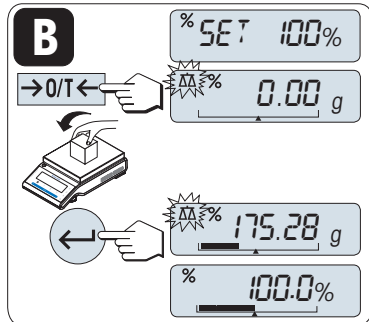

Setting possibility

B Setting the reference by weighing mode (weigh 100%)

- a) Press «→0/T←» to tare the balance and to activate the weighing mode. If needed: place empty container on the weighing pan and tare again.
- b) Load the reference weight (100%).
Note: Reference weight must be at least +/- 10d.
- c) Press «←» to confirm.

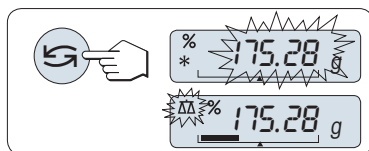

Switching between manual mode and weighing mode

- Press «↻» to switch between manual and weighing mode.

Note: By switching from weighing mode to manual mode the weight value will be transferred and can be changed manually.

Note: If without any key press within 60 seconds, the balance returns to the previous active application.

On completion of the weighing-in procedure, your balance is ready for percent weighing.

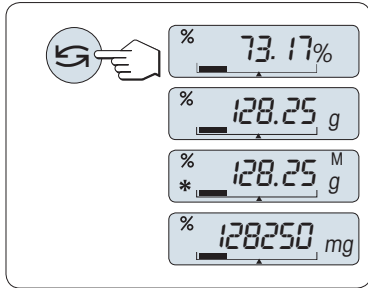

Switching between percent and weight display

You can use the «» key at any time to switch the display between percent display, weighing unit "UNIT 1", "RECALL" value (if activated) and weighing unit "UNIT 2" (if different from UNIT 1).

Note:

- The recall value is displayed with an asterisk (*) as well as icon "M" and can not be printed.
- The current set weight remains stored until it is redetermined.

9 Application "Check Weighing"

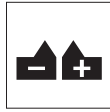

The "**Check weighing**" application allows you to check the deviation of a sample weight within a tolerance limit to a reference target weight.

Requirement: The function "CHECK" must be assigned to an «Fx» key (see advanced menu topic "ASSIGN:Fx", factory setting: F3).

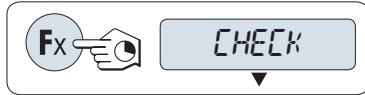

- Activate function "CHECK" by pressing and holding the appropriate assigned «Fx» key (factory setting: F3).

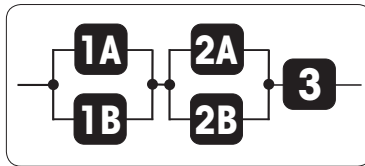

Step 1: Check Weighing first requires the setting of a reference weight that should corresponds to the nominal weight, there are 2 possibilities:

1A Setting the reference **in manual mode** (enter nominal weight).

1B Setting the reference **in weighing mode** (weigh nominal weight).

Step 2: Check weighing needs the upper and lower limits, there are 2 possibilities::

2A Setting the **upper and lower limits in percentage**.

2B Setting the **upper and lower limits by weight**.

Step 3: Setting tolerance beep

3 Activate or deactivate **tolerance beep**.

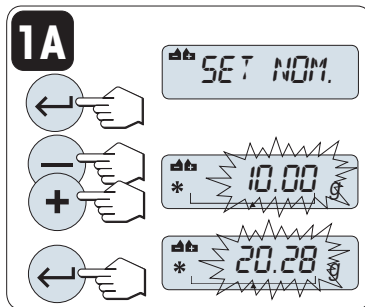

Step 1, setting possibility:

1A **Setting the reference by manual mode** (enter nominal weight)

- Press «←» to activate manual mode.
- Select the reference target weight by scrolling up («+» key) or down («-» key). Speed up by press and hold.
- Press «←» to confirm the nominal weight.

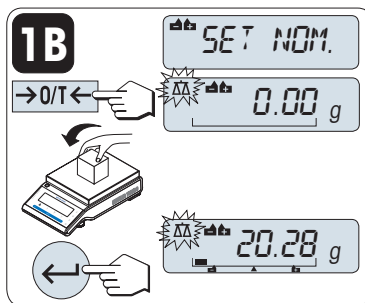

Step 1, setting possibility:

1B **Setting the reference by weighing mode** (weigh nominal weight)

- Press «→0/T←» to tare the balance and to activate the weighing mode. If using: place empty container on the weighing pan first or tare again.
- Load the nominal weight.
- Press «←» to confirm the nominal weight.

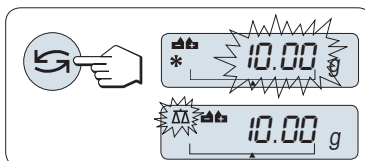

Switching between manual mode and weighing mode

- Press «↻» to switch between manual mode and weighing mode.

Note: By switching from weighing mode to manual mode the weight value will be transferred and can be changed manually.

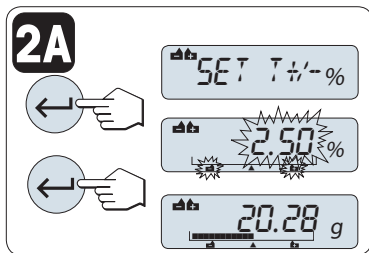

Step 2, setting possibility:

2A Setting the upper and lower limits (in percentage):

- Press «←» to start setting.
- Press «←» to confirm the default limit of +/- 2.5 % or enter the limit value by scrolling up («+» key) or down («-» key). Press «←» to confirm the limits.

Note: Press «↶» to switch between "UNIT 1" and Unit "%".

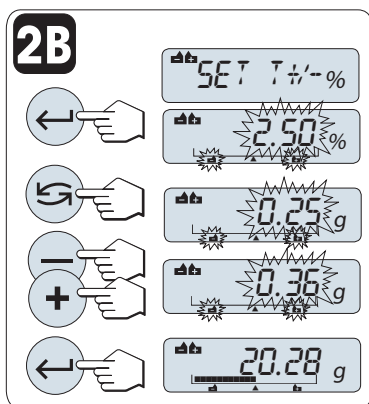

Step 2, setting possibility:

2B Setting the upper and lower limits by weight:

- Press «←» to start setting.
- Press «↶» to switch to UNIT 1.
- Press «←» to confirm the default limit or enter the limit value by scrolling up («+» key) or down («-» key). Press «←» to confirm the limits.

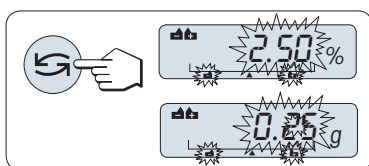

Switching between percentage and weight unit 1

- Press «↶» to switch between setting in percentage and setting by weight.

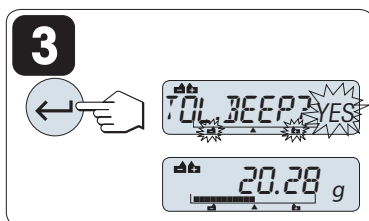

Step 3:

3 Setting tolerance beep:

The tolerance beep indicates whether the weighing sample lies within the tolerance by beeping three times.

Note: The beep level corresponds to the setting in menu topic "STAB.BEEP" (Basic menu). If "STAB.BEEP" is set to "OFF", the tolerance beep level is medium.

- To activate tolerance beep press «←». To deactivate tolerance beep press «↶» to select "NO and press «←».

Note:

- If without any key press within 60 seconds, the balance returns to the previous active application. Press «C» to cancel.
- The nominal weight must be at least 10 digit.

On completion of the setting procedure, your balance is ready for checkweighing.

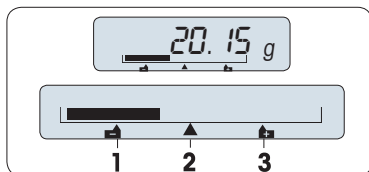

Weighing-in-Aid

The Weighing-in-Aid helps you quickly determine the position of the sample weight regarding the tolerance.

- Lower limit
- Target weight
- Upper limit

10 Application "Statistics"



The "Statistics" application allows you to generate statistics of weighing values. 1 to 999 values are possible. **Requirement:** The function "STAT" must be assigned to an «Fx» key (see advanced menu topic "ASSIGN:Fx"). Connect a printer or a PC if present.

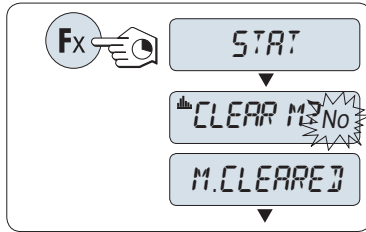

- Activate function "STAT" by pressing and holding the appropriate assigned «Fx» key.
- To continue the last statistics press «←». For a new statistical evaluation press «↶» to select "Yes" and press «←» to clear the memory.

Note: If the memory is already cleared (sample counter is 0) the memory clear question will be not displayed.

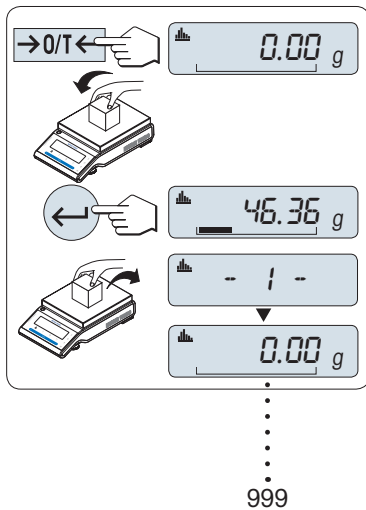

Weighing the first sample weight:

- Press «→O/T←» to zero/tare the balance if needed.
- Load the first sample weight.
- Press «←». The display shows the sample count "- 1 -" and the current weight is stored as sample and the weight is printed out.

Note: When the sample counter is displayed you may press «C» to undo (drop) this sample.

- Unload the first sample weight.

Weighing further sample weights:

The same procedure as for the first sample weight.

- 1...999 samples are possible.
- The next value will be accepted if the sample weight is in the range 70% –130% of the current average value. "OUT OF RANGE" will be displayed if the sample is not accepted.



Results:

- If the numbers of sample are greater than or equal to 2, press «≡», the results are displayed and printed.

Displayed results:

- Press «←» to show the next statistical value.
- Press «C» to cancel displaying results and to continue weighing next sample.

		0.5 seconds
number of samples		
average		
standard deviation		
relative standard deviation		
lowest value (minimum)		
highest value (maximum)		
different between the minimum and the maximum		

Displayed results:

- a) Press «←» to show the next statistical value.
- b) Press «C» to cancel displaying results and to continue weighing next sample.

sum of all values



Printout:

```
----- Statistics -----  
21.Jan 2009          12:56  
  
METTLER TOLEDO  
  
Balance Type      MS4002S  
SNR                1234567890  
-----  
1                  46.36 g  
2                  55.81 g  
3                  47.49 g  
4                  53.28 g  
5                  49.71 g  
n                   5  
x                  50.530 g  
s dev              3.961 g  
s rel              7.84 g  
Min.               46.36 g  
Max.               55.81 g  
Diff               9.45 g  
Sum                252.65 g  
-----
```

11 Application "Formulation" (Net Total Formulation)



The **"Formulation"** (Net Total) application allows you to

- weigh in (add and store) up to 999 individual component weights and displays the total. If a printer is connected, the component weights are printed individually and as a total.
- tare/pre-tare and store up to 999 container weights and displays the total. If a printer is connected, the tare weights are printed out individually and as a total.

Requirement: The function "FORMULA" must be assigned to an «Fx» key (see advanced menu topic "ASSIGN:Fx"). Connect a printer or a PC if present.

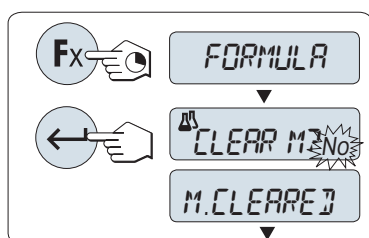

- Activate function formulation "FORMULA" by pressing and holding the appropriate assigned «Fx» key.
- Press «←» to continue formulation weighing. For a new formulation press «↶» (or «+» or «-») to select "Yes" and press «←» to clear the memory.

Note: If the memory is already cleared (sample and tare/pre-tare counter is zero) the memory clear question will be not displayed.

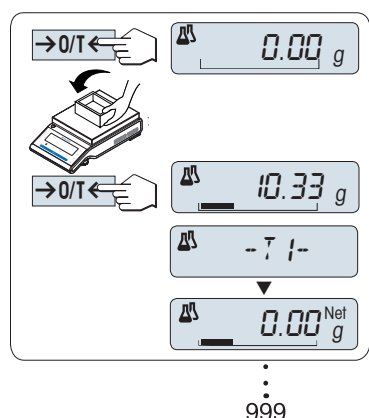

Tare container (if used):

- Press «→0/T←» to zero or tare the balance if needed.
- Place the empty container on the weighing pan.
- Press «→0/T←». The container is tared and the tare count "- T 1 -" is displayed and the tare weight is printed.

Note:

- If you pre-tare via MT-SICS (e.g. bar code reader) "- PT1 -" is displayed.
- Zero range setting (menu topic "ZERO RNG") has no effect. The zero-limit is less than or equal 10d.

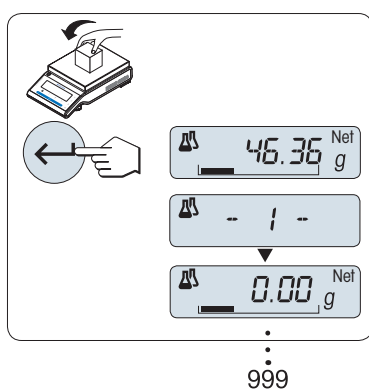

Weighing the first component weight:

- Load the first component weight.
- Press «←». The display briefly shows the component count "- 1 -", the current weight is stored as sample and the component weight is printed. The display is set back to zero.

Weighing further component weights:

The same procedure as for the first component weight with the same or new container).

- 1...999 sample values are possible.
- max 999 tare values are possible.
- max 999 pre-tare values are possible.

Results:

- If the numbers of sample are greater than or equal to 2, press «≡», the results are displayed and printed.

Displayed results:

- Press «←» to show the next statistical value.

0.5 seconds
number of samples 8

b) Press «C» to cancel displaying results and to continue weighing next component.

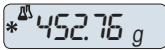
sum of all tare values (T and PT)   ←

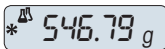
sum of all component gross weight values   ←

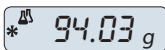
sum of all component net weight values   ←

Printout:

```

----- Formulation -----
21.Jan 2009          12:56

METTLER TOLEDO

Balance Type      MS4002S
SNR               1234567890
-----
1 T                10.33 g
1 N                8.85 g
2 N                9.23 g
2 T                10.84 g
3 N                7.43 g
.
.
n                   8
T Total           452.76 g
G Total           546.79 g

N Total           94.03 g
-----

```

12 Application "Totaling"

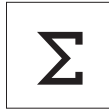

The **"TOTALING"** application allows you to weigh in different samples to add their weight values and to totalize them. 1 to 999 samples are possible.

Requirement: The function "TOTALING" must be assigned to an «Fx» key (see advanced menu topic "ASSIGN:Fx").

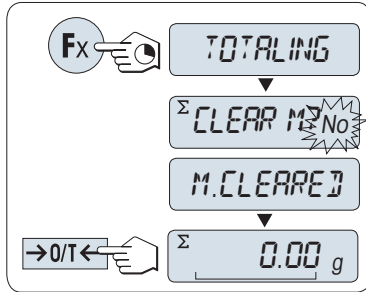

- Activate function "TOTALING" by pressing and holding the appropriate assigned «Fx» key.
- For a new totaling evaluation press «↶» (or «+» or «-») to enter "Yes" and press «↵» to clear the memory.
Note: If the memory is already cleared (sample counter is 0) the memory clear question will be not displayed.
- Press «→0/T←» to zero or tare the balance.

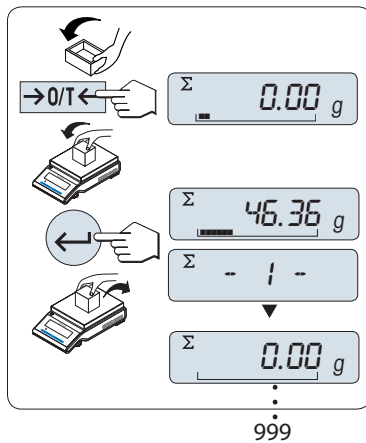

Weighing in the sample weight:

- If using a container: place empty container on the weighing pan and press «→0/T←» to zero or tare the balance.
- Load the first sample weight.
- Press «↶». The display shows the sample count "- 1 -" and the current weight is stored.
Note: When the sample counter is displayed you may press «C» to undo (drop) this sample.
- Unload the first sample weight. The display shows zero.

Weighing in further sample weights:

The same procedure as for the first sample weight.

- 1...999 samples are possible.



Results:

- If the numbers of sample are greater than or equal to 2, press «», the results are displayed and printed.

Displayed results:

- Press «↶» briefly to show the totalized value.
- Press «C» briefly to cancel.

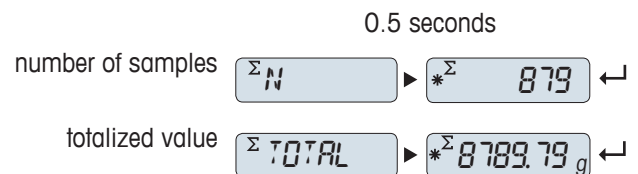

Printout:

```
----- Totaling -----  
21.Jan 2009      12:56  
  
METTLER TOLEDO  
  
Balance Type      MS1602S  
SNR                1234567890  
-----  
1                  46.36 g  
2                  55.81 g  
3                  47.49 g  
4                  53.28 g  
5                  49.71 g  
6                  53.93 g  
.  
.  
.  
n                      879  
Total              8789.79 g  
-----
```

13 Application "Dynamic Weighing"

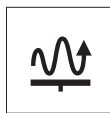

The "**Dynamic Weighing**" application allows you to determine the weights of unstable samples or to determine weights under unstable ambient conditions. The balance calculates the weight as the average of a number of weighing operations over a defined time.

Requirement: The function "DYNAMIC" must be assigned to an «Fx» key (see advanced menu topic "ASSIGN:Fx").

Note: "Switching Units" and "RECALL" Functions are not available in this Application.



- Activate function "DYNAMIC" by pressing and holding the appropriate assigned «Fx» key.

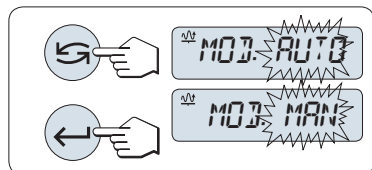

1 Setting "Auto Start" or "Manual Start":

- Press «←» to select the mode:
 - "**Auto Start**" "MOD. AUTO" (default value). The weighing starts automatically on relative stability. However, the weighing sample must weigh at least 5 grams. For weighing samples below 5 g the weighing must be started manually.
 - "**Manual Start**" "MOD. MAN"
- Press «←» to confirm the selection.

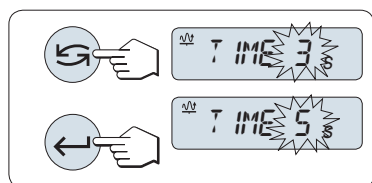

2 Setting the weighing time:

- Press «←» to select one of the available time intervals: 3 (default value), 5, 10, 20, 60 and 120 seconds.
- Press «←» to confirm the selected time interval.

Note: If without any key press within 60 seconds, the balance returns to the previous active application. Press «C» to cancel and returns to the previous active application.

Your balance is now ready for dynamic weighing:

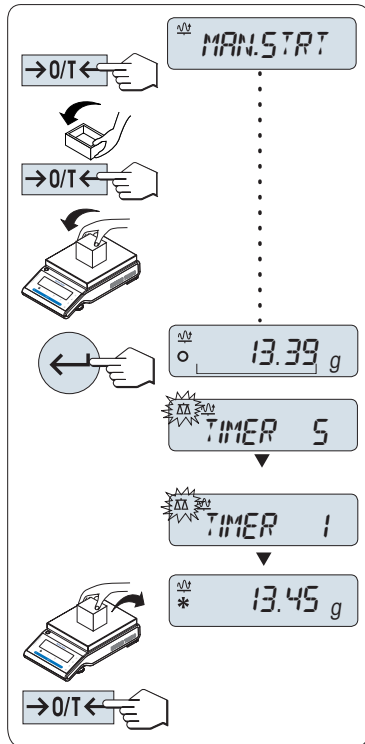

- a) Press « $\rightarrow 0/T \leftarrow$ » to zero if needed.
- b) If using a container: place empty container on weighing pan and press « $\rightarrow 0/T \leftarrow$ » to tare the balance.
- c) Load sample weight.
- d) – If you have selected function "**Manual Start**" "MAN.STRT", press « \leftarrow » to start the weighing.
– If you have selected function "**Auto Start**" "AUTO.STRT", the weighing starts automatically on relative stability. For weighing samples below 5 g the weighing must be started manually by pressing « \leftarrow ».
- e) Read off result. The result of the dynamic weighing is displayed with an asterisk (* = calculated value).
- f) Unload sample weight.
- g) "**Manual Start**" only, press « $\rightarrow 0/T \leftarrow$ » to zero and go back to "MAN.STRT".

Note:

- The remaining weighing time (in seconds) is displayed continuously. You can cancel the countdown by pressing «**C**».
- The weight value remains in the display until the sample weight is removed from weighing pan ("Auto Start" only) or « $\rightarrow 0/T \leftarrow$ » is pressed.

14 Application "Multiplication Factor Weighing"



The "Multiplication Factor Weighing" application allows you to multiply the weight value (in grams) by a predefined factor (result = factor * weight) and have it calculated to a predefined number of decimal places.

Requirement: The function "FACTOR M" must be assigned to an «Fx» key (see advanced menu topic "ASSIGN:Fx").



- Activate function "FACTOR M" by pressing and holding the appropriate assigned «Fx» key.

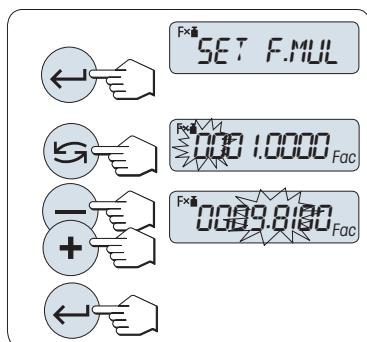

1 Setting the factor value:

- Press «**↵**» to execute "SET F.MUL". Either the factor 1 appears as default value or the factor that was saved most recently.
- Press «**↶**» to select a digit. The selected digit is blinking.
- For changing digits, press «**+**» to scroll up or «**-**» to scroll down.
- Press «**↵**» to confirm the selected factor (no automatic acceptance).

Note: Zero for multiplication factor value is outside the allowed range, the error message "FACTOR OUT OF RANGE" will be displayed.

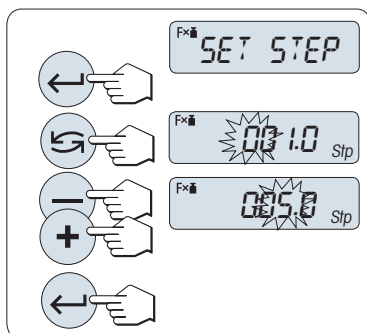

2 Setting the step value:

"SET STEP" appears in the display, and the program changes automatically to allow the display increments to be entered. The smallest possible display increment appears as default value, or the last value that was saved.

- Press «**↵**» to execute "SET STEP".
- Press «**↶**» to select a digit. The selected digit is blinking.
- For changing digits, press «**+**» to scroll up or «**-**» to scroll down.
- Press «**↵**» to confirm the selected step (no automatic acceptance).

Note: The allowed range for the step depends on the factor and the resolution of the balance. If it is outside the allowed range the error message "STEP OUT OF RANGE" will be displayed.

Note: If without any key press within 60 seconds, the balance returns to the previous active application. Press «**C**» to cancel.

On completion of the setting procedure, your balance is ready for multiplication factor weighing.

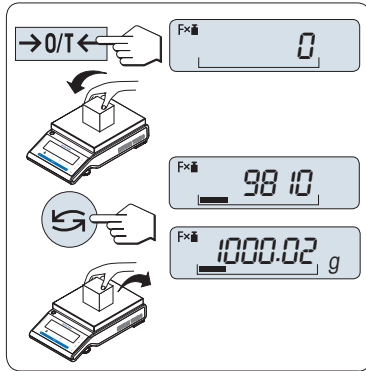

Weighing procedure

- Press «→0/T←» to zero/tare.
- Load sample weight on weighing pan.
- Read the result. The appropriate calculation is then made using the weight of sample and the selected factor, the result being displayed with the selected display step.
Note: No units are displayed.
- Unload sample weight.

Toggle between displaying the calculated value and the measured weight:

You can use the «G» key to toggle between the calculated Value, weight value "UNIT 1", "RECALL" value (if selected) and weight value "UNIT 2" (if different from "UNIT 1").

15 Application "Division Factor Weighing"



The "Division Factor Weighing" divide a predefined factor (in grams) by the weight value (result = factor / weight) and have it rounded to a predefined number of decimal places.

Requirement: The function "FACTOR D" must be assigned to an «Fx» key (see advanced menu topic "ASSIGN:Fx").



- Activate function "FACTOR D" by pressing and holding the «Fx» key.

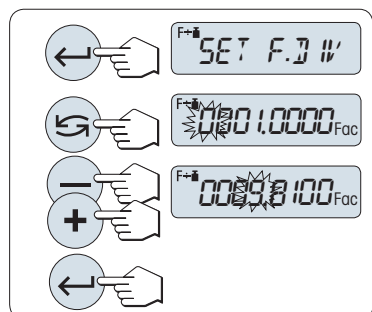

1 Setting the Factor Value:

- Press «←» to execute "SET F.DIV". Either the factor 1 appears as default value or the factor that was saved most recently.
- Press «→» to select a digit. The selected digit is blinking.
- For changing digits, press «+» key to scroll up or «-» to scroll down.
- Press «←» briefly to confirm the selected factor (no automatic acceptance).

Note: Zero for division factor value is outside the allowed range, the error message "FACTOR OUT OF RANGE" will be displayed.

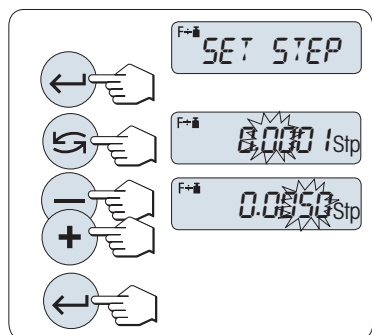

2 Setting the step value:

"SET STEP" appears in the display, and the program changes automatically to allow the display increments to be entered. The smallest possible display increment appears as default value, or the last value that was saved.

- Press «←» to execute "SET STEP".
- Press «→» to select a digit. The selected digit is blinking.
- For changing digits, press «+» to scroll up or «-» to scroll down.
- Press «←» to confirm the selected step (no automatic acceptance).

Note: The allowed range for the step depends on the factor and the resolution of the balance. If it is outside the allowed range the error message "STEP OUT OF RANGE" will be displayed.

Note: If without any key press within 60 seconds, the balance returns to the previous active application. Press «C» to cancel and returns to the previous active application.

On completion of the setting procedure, your balance is ready for division factor weighing.

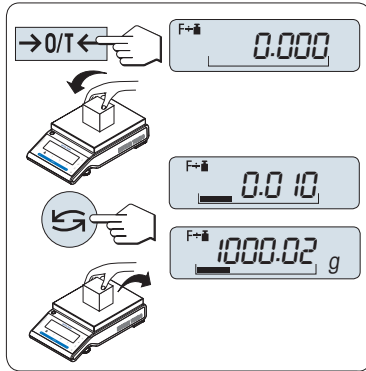

Weighing procedure

- a) Press «→0/T←» to zero/tare.
- b) Load sample weight on weighing pan.
- c) Read the result. The appropriate calculation is then made using the weight of sample and the selected factor, the result being displayed with the selected display step.
Note: No units are displayed. To avoid a division by zero, the factor division is not calculated at zero.
- d) Unload sample weight.

toggling between displaying the calculated value and the measured weight:

You can use the «G» key to toggle between the calculated Value, weight value "UNIT 1", "RECALL" value (if selected) and weight value "UNIT 2" (if different from "UNIT 1").

16 Application "Density"



The **"Density"** application allows you to determine the density of solid bodies and liquids. Determination of the density uses **Archimedes' principle** according to which a body immersed in a fluid undergoes an apparent loss in weight which is equal to the weight of the fluid it displaces.

To determine the density of solid bodies, we recommended you to work with the optional density kit which contains all the attachments and aids needed for convenient and precise density determination. To determine the density of liquids, you additionally need a sinker which you can also obtain from your METTLER TOLEDO dealer.

Note for performing of density determinations:

- You can also use the hanger for weighing below the balance which belongs to your balance.
- We recommended you to consult the operating instructions enclosed with the density kit.
- If a METTLER TOLEDO printer is attached to your balance, the settings will be automatically recorded.

Requirement: The function "DENSITY" must be assigned to an «Fx» key (see advanced menu topic "ASSIGN:Fx"). Density kit is installed.



- Activate function "DENSITY" by pressing and holding the appropriate assigned «Fx» key.

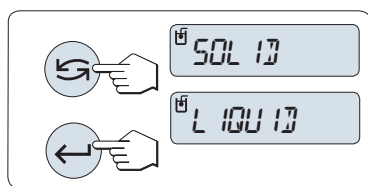

Setting the method for density determination

- Select:
"SOLID", the function for the density determination of solids, or
"LIQUID", the function for the density determination of liquids with a sinker.
- Press «←» to confirm the selection

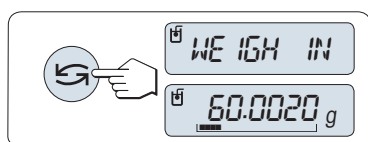

Switching the display between user guidance and weighing

- Press «→» to toggle the display between user guidance and weighing.

16.1 Density Determination of Solids

Requirement: The method "SOLID" is set.

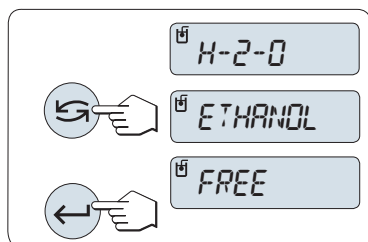

Setting the parameter of the auxiliary liquid

- Select the auxiliary liquid by scrolling with «→» (or «-» up / «+» down):
"H-2-O" for distilled water, "ETHANOL" or "FREE" for a freely definable auxiliary liquid.
- Press «←» to confirm the selection.

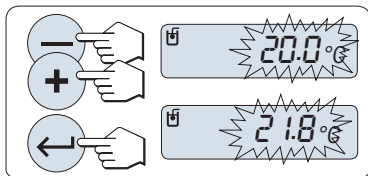

If you have selected water or ethanol as the auxiliary liquid:

- Enter the current temperature of the auxiliary liquid (read off on thermometer). Change the value by scrolling up «+» or down «-».
- Press «←» to confirm the value.

Note: The densities of distilled water and ethanol in the range 10 °C to 30.9 °C are stored in the balance.

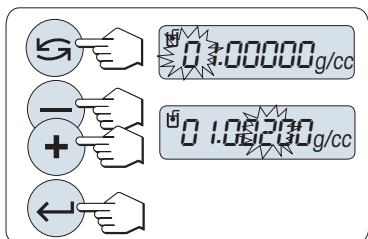

If you have selected a freely definable auxiliary liquid:

Enter the density of the auxiliary liquid at the current temperature (read off on thermometer).

- Press «↶» to select a digit. The selected digit is blinking.
- For changing digits, press «+» to scroll up or «-» to scroll down.
- Press «←» to confirm the selected value.

Note: If without any key press within 60 seconds or by pressing «C», the balance returns to the previous active application.

On completion of the settings, your balance is ready for performing the density determination of liquids.

Note: Taring the balance is possible at any time.

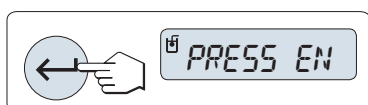

The balance prompts you: "PRESS ENTER TO START".

- Press «←» to start. Tare/Zero is executed.

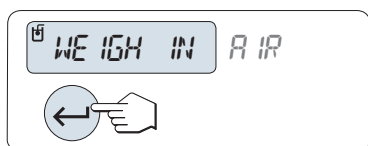

The balance prompts you to weigh the solid in air "WEIGH IN AIR".

- Load the solid.
- Press «←» to initiate the measurement.

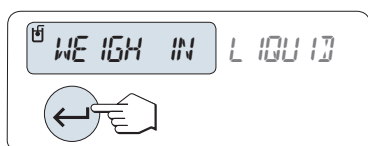

The balance prompts you to weigh the solid in the auxiliary liquid "WEIGH IN LIQUID".

- Load the solid.
- Press «←» to initiate the measurement.

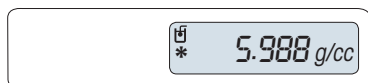

The balance now shows the determined density of the solid.

Note:

- This result has already been corrected for the air buoyancy. The buoyancy caused by the two immersed wires (Ø 0.6 mm) can be neglected.
- By pressing «C», the balance returns to "PRESS ENTER TO START".

Result:

Press «⏏», the result will be printed.



Sample printout:

```

---- Density Solid ----
18.Mar 2010          20:14
Balance Type      MS204S
SNR                1234567890
-----

ID:                .....

Liquid:
H-2-O             0.99822 g/cm3
Temp.             20.0 °C
Weight in air:
                  60.0020 g
Weight in liquid:
                  49.9997 g
Volume of solid:
                  1.625 cm3

Density:          5.988 g/cm3
                  =====

Signature
.....
-----
    
```

16.2 Density Determination of Liquids

Requirement: The method "LIQUID" is set.

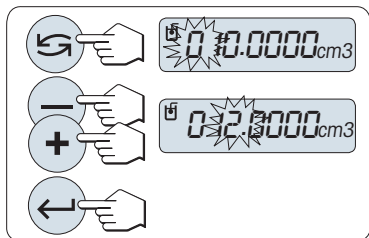

Setting the displacement volume of your sinker

Press «←» to confirm the default value of 10.0 cm³ or change it if needed:

- a) Press «←» to select a digit. The selected digit is blinking.
- b) For changing digits, press «+» to scroll up or «-» to scroll down
- c) Press «←» to confirm the selected value.

Note: If without any key press within 60 seconds or by pressing «C», the balance returns to the previous active application.

On completion of the settings, your balance is ready for performing the density determination of liquids.

Note: Taring the balance is possible at any time.



The balance prompts you: "PRESS ENTER TO START".

- Press «←» to start.



The balance prompts you to weigh the sinker in air "WEIGH IN AIR".

- a) Position the sinker.
- b) Press «←» to initiate the measurement.

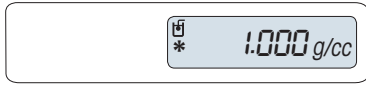
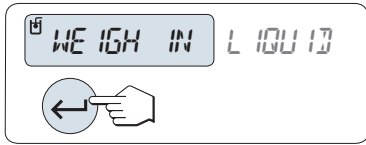

Sample printout:

```

---- Density Liquid ----
18.Mar 2010      20:14
Balance Type    MS204S
SNR             1234567890
-----
ID:             .....
Temp. of liquid:
                .....
Displaced liquid:
                10.0023 g
Density:        1.000 g/cm3
                =====
Signature
                .....
-----

```

The balance prompts you to weigh the sinker in the liquid "WEIGH IN LIQUID".

- a) Pour the liquid into the beaker. Make sure that the sinker is immersed by at least 1 cm in the liquid, and that there are no air bubbles in the container.
- b) Press «←» to initiate the measurement.

The balance now shows the determined density of the liquid at the current temperature (read off on the thermometer).

Note:

- This result has already been corrected for the air buoyancy. The buoyancy caused by the immersed wire (Ø 0.2 mm) of the sinker can be neglected.
- By pressing «C», the balance returns to "PRESS ENTER TO START".

Result:

Press «☐», the result will be printed.

16.3 Formulae Used to Calculate Density

The "DENSITY" Application is based on the formulae listed below.

Formulae for determining the density of solids with compensation for air density

$$\rho = \frac{A}{A-B} (\rho_0 - \rho_L) + \rho_L$$

$$V = \alpha \frac{A - B}{\rho_0 - \rho_L}$$

ρ = Density of the sample

A = Weight of the sample in air

- B = Weight of the sample in the auxiliary liquid
 V = Volume of the sample
 ρ_0 = Density of the auxiliary liquid
 ρ_L = Density of Air (0.0012 g/cm³)
 α = Weight correction factor (0.99985), to take the atmospheric buoyancy of the adjustment weight into account

Formula for determining the density of liquids with compensation for air density

$$\rho = \alpha \frac{P}{V} + \rho_L$$

- ρ = Density of the liquid
 P = Weight of the displaced liquid
 V = Volume of the sinker
 ρ_L = Density of air (0.0012 g/cm³)
 α = Weight correction factor (0.99985), to take the atmospheric buoyancy of the adjustment weight into account

Density Table for Distilled Water

T/°C	0.0	0.1	0.2	0.3	0.4	0.5	0.6	0.7	0.8	0.9
10.	0.99973	0.99972	0.99971	0.99970	0.99969	0.99968	0.99967	0.99966	0.99965	0.99964
11.	0.99963	0.99962	0.99961	0.99960	0.99959	0.99958	0.99957	0.99956	0.99955	0.99954
12.	0.99953	0.99951	0.99950	0.99949	0.99948	0.99947	0.99946	0.99944	0.99943	0.99942
13.	0.99941	0.99939	0.99938	0.99937	0.99935	0.99934	0.99933	0.99931	0.99930	0.99929
14.	0.99927	0.99926	0.99924	0.99923	0.99922	0.99920	0.99919	0.99917	0.99916	0.99914
15.	0.99913	0.99911	0.99910	0.99908	0.99907	0.99905	0.99904	0.99902	0.99900	0.99899
16.	0.99897	0.99896	0.99894	0.99892	0.99891	0.99889	0.99887	0.99885	0.99884	0.99882
17.	0.99880	0.99879	0.99877	0.99875	0.99873	0.99871	0.99870	0.99868	0.99866	0.99864
18.	0.99862	0.99860	0.99859	0.99857	0.99855	0.99853	0.99851	0.99849	0.99847	0.99845
19.	0.99843	0.99841	0.99839	0.99837	0.99835	0.99833	0.99831	0.99829	0.99827	0.99825
20.	0.99823	0.99821	0.99819	0.99817	0.99815	0.99813	0.99811	0.99808	0.99806	0.99804
21.	0.99802	0.99800	0.99798	0.99795	0.99793	0.99791	0.99789	0.99786	0.99784	0.99782
22.	0.99780	0.99777	0.99775	0.99773	0.99771	0.99768	0.99766	0.99764	0.99761	0.99759
23.	0.99756	0.99754	0.99752	0.99749	0.99747	0.99744	0.99742	0.99740	0.99737	0.99735
24.	0.99732	0.99730	0.99727	0.99725	0.99722	0.99720	0.99717	0.99715	0.99712	0.99710
25.	0.99707	0.99704	0.99702	0.99699	0.99697	0.99694	0.99691	0.99689	0.99686	0.99684
26.	0.99681	0.99678	0.99676	0.99673	0.99670	0.99668	0.99665	0.99662	0.99659	0.99657
27.	0.99654	0.99651	0.99648	0.99646	0.99643	0.99640	0.99637	0.99634	0.99632	0.99629
28.	0.99626	0.99623	0.99620	0.99617	0.99614	0.99612	0.99609	0.99606	0.99603	0.99600
29.	0.99597	0.99594	0.99591	0.99588	0.99585	0.99582	0.99579	0.99576	0.99573	0.99570
30.	0.99567	0.99564	0.99561	0.99558	0.99555	0.99552	0.99549	0.99546	0.99543	0.99540

Density Table for Ethanol

T/°C	0.0	0.1	0.2	0.3	0.4	0.5	0.6	0.7	0.8	0.9
10.	0.79784	0.79775	0.79767	0.79758	0.79750	0.79741	0.79733	0.79725	0.79716	0.79708
11.	0.79699	0.79691	0.79682	0.79674	0.79665	0.79657	0.79648	0.79640	0.79631	0.79623
12.	0.79614	0.79606	0.79598	0.79589	0.79581	0.79572	0.79564	0.79555	0.79547	0.79538
13.	0.79530	0.79521	0.79513	0.79504	0.79496	0.79487	0.79479	0.79470	0.79462	0.79453
14.	0.79445	0.79436	0.79428	0.79419	0.79411	0.79402	0.79394	0.79385	0.79377	0.79368
15.	0.79360	0.79352	0.79343	0.79335	0.79326	0.79318	0.79309	0.79301	0.79292	0.79284
16.	0.79275	0.79267	0.79258	0.79250	0.79241	0.79232	0.79224	0.79215	0.79207	0.79198
17.	0.79190	0.79181	0.79173	0.79164	0.79156	0.79147	0.79139	0.79130	0.79122	0.79113
18.	0.79105	0.79096	0.79088	0.79079	0.79071	0.79062	0.79054	0.79045	0.79037	0.79028
19.	0.79020	0.79011	0.79002	0.78994	0.78985	0.78977	0.78968	0.78960	0.78951	0.78943
20.	0.78934	0.78926	0.78917	0.78909	0.78900	0.78892	0.78883	0.78874	0.78866	0.78857
21.	0.78849	0.78840	0.78832	0.78823	0.78815	0.78806	0.78797	0.78789	0.78780	0.78772
22.	0.78763	0.78755	0.78746	0.78738	0.78729	0.78720	0.78712	0.78703	0.78695	0.78686
23.	0.78678	0.78669	0.78660	0.78652	0.78643	0.78635	0.78626	0.78618	0.78609	0.78600
24.	0.78592	0.78583	0.78575	0.78566	0.78558	0.78549	0.78540	0.78532	0.78523	0.78515
25.	0.78506	0.78497	0.78489	0.78480	0.78472	0.78463	0.78454	0.78446	0.78437	0.78429
26.	0.78420	0.78411	0.78403	0.78394	0.78386	0.78377	0.78368	0.78360	0.78351	0.78343
27.	0.78334	0.78325	0.78317	0.78308	0.78299	0.78291	0.78282	0.78274	0.78265	0.78256
28.	0.78248	0.78239	0.78230	0.78222	0.78213	0.78205	0.78196	0.78187	0.78179	0.78170
29.	0.78161	0.78153	0.78144	0.78136	0.78127	0.78118	0.78110	0.78101	0.78092	0.78084
30.	0.78075	0.78066	0.78058	0.78049	0.78040	0.78032	0.78023	0.78014	0.78006	0.77997

Density of C₂H₅OH according to the "American Institute of Physics Handbook".

17 Application "Routine Test"



The "**Routine Test**" application allows you to determine the sensitivity of the balance. More about periodic sensitivity tests (routine tests) see: **GWP**[®] (Good Weighing Practice) on www.mt.com/gwp.

GWP gives clear recommendation for routine testing:

- how should I test my balance?
- how often?
- where can I reduce efforts?

More about test weights see www.mt.com/weights.

Requirement:

- The function "R. TEST" must be assigned to «F3» key (see advanced menu topic "ASSIGN:F3").
- It is recommended to connect a printer or a PC to the balance for showing the results.

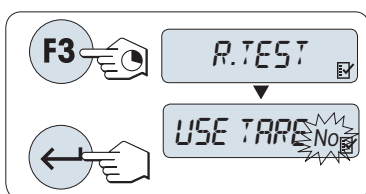

- Activate function "R. TEST" by pressing and holding the assigned «F3» key.
- Select "No" (no tare weight used). If a tare weight is used during the test select "Yes" (use a tare weight). To toggle between "Yes" and "No" use «↶» (or «+» or «-»).
- Press «←» to confirm the selection.

Note:

- It is recommended to test the sensitivity without tare load. (factory setting "No").
- If using tare: Make sure that tare weight plus test weight is not exceeding max. load.

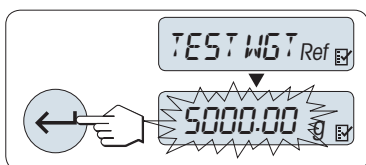

Setting the reference test weight value

The default value of the test weight: Next smaller OIML weight than the maximum load of your balance according to the GWP[®] recommendation.

- For changing the value, press «+» to scroll up or «-» to scroll down. Progressing speed by press and hold.
- Press «←» to confirm the value.

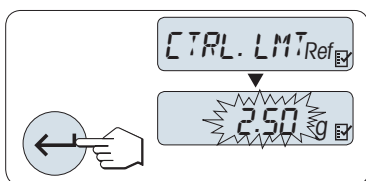

Setting the Control Limit

The default value of the control limit:

Test weight x weighing process tolerance / 2

Example: 5000 g x 0.1% / 2 = 2.50 g.

- For changing the value, press «+» to scroll up or «-» to scroll down. Progressing speed by press and hold.
- Press «←» to confirm the value.

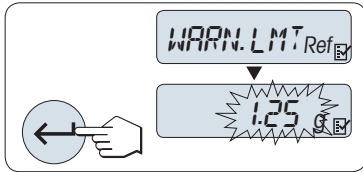

Setting the Warning Limit

The default value of the warning limit:
 Warning limit = control limit / safety factor
 Example: 2.5 g / 2 = 1.25 g.

- For changing the value, press «+» to scroll up or «-» to scroll down. Progressing speed by press and hold.
- Press «←» to confirm the value.

Note: The default values of control limit and the warning limit are evaluated according the GWP recommendation. These are based under the assumption that the weighing process tolerance is 0.1% and the safety factor is 2.

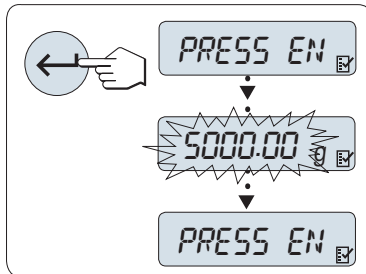

On completion of the setting procedure, your balance is ready for the routine test procedure.

Note: The test weight must be acclimatized to the ambient temperature of the balance.

- Press «←» to start the test.
- Follow the instructions on the display. If the test weight value is flashing: Load the test weight (displayed value).

The printout starts after the weighing pan is unloaded.

Exit the current test procedure:

- Press and hold «ΔΔ», «F1», «F2» for executing a new application.

Printout:

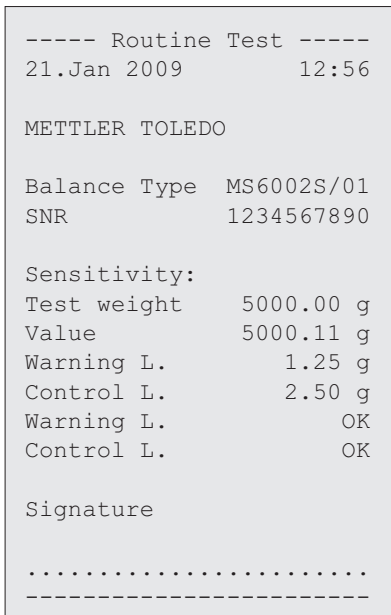

What if Warning Limit or Control Limit are "FAILED"?

The "SOP for Periodic Sensitivity Tests (Routine Tests)" provides information about measures when routine tests fail. Find a download version of these SOPs on www.mt.com/gwp, link "GWP® The Program / Routine Operation".

Content of SOP:

- Preparation
- Test procedure

- Evaluation
- Deviation
 - If Warning Limit "FAILED"
 - If Control Limit "FAILED"

18 Application "Diagnostics"



The "**Diagnostics**" application allows you to carry out predefined diagnostics tests and to view or print predefined sets of balance information. This diagnostics tool helps you find errors faster and more efficiently.

Requirement: A printer or a PC is connected to the balance for showing the results.

- a) Activate "ADVANCED" menu. (See section menu operation)
- b) Activate function "DIAGNOSE" by pressing «←↓».
- c) Use «←G» to select appropriate tests.

18.1 Repeatability Test

The repeatability test allows you to repeat tests with internal weight for a given number of times.

Note: On models with internal weights only.

- a) Press «←↓» to activate repeatability test "REPEAT.T". "R. TST. 10" appears on the Display.
- b) Enter the number of times (blinking) by pressing «+» or «-». Possible values are 5, 10 (default), 20, 50, 100 times.
- c) Press «←↓» to start the test. The message "RUNNING REPEAT TEST" is displayed till the tests are completed.
- d) Press «←≡» to print the test information..
- e) Press «←↓» to scroll forward through the displayed list.
- f) Press «C» to cancel the test procedure. The balance will return to the topic "DIAGNOSE".

Sample Information Displayed:

Displayed for 0.5 s	Display
"S DEV"	* 0.004 g
"MAX. TEMP"	21.2 °C
"MIN. TEMP"	21.0 °C
"MEAN. TEMP"	21.1 °C
"TOT.TIME"	00:01:26

Sample Printout:

```
-- Repeatability Test --
21.Jan 2009      11:34

METTLER TOLEDO

Balance Type  MS6002S/01
SNR           1234567890
SW            V1.00
Temperature   21.3 °C
No. of tests  10
-----
1. Time       00:00:00
1. Temp.     21.3 °C
2. Time       00:00:04
2. Temp.     21.3 °C
.
.
.
-----
s Dev.       0.004 g
Max Temp.    21.2 °C
Min Temp.    21.0 °C
Mean Temp.   21.1 °C
Total Time   00:00:44
-----
```



Examples:

Repeatability test is a tool to do functional check with the balance. It may be performed:

- **To check function of balance**
 - during installation to store print out with installation documents.
 - after preventative maintenance to store print out with installation maintenance report.
 - when remarkable decrease of weighing performance occurs, so that you can email/fax print out to service support provider for diagnose purposes.
- **To develop the optimal environment settings** (see menu topic "ENVIRON.").
Measure the time you need to perform repeatability test with each "STABLE", "STANDARD" and "UNSTABLE" setting. The setting with the fastest total time suits best for the existing environmental conditions.

18.2 Display Test

The display test allows you to test the display of the balance.

- a) Press «» to start "DISPLAY".
All possible segments and icons on the display will illuminate.
- b) Press «» to print the test information.
- c) Press «**C**» to cancel the test procedure. The balance will return to the topic "DIAGNOSE".

Sample Printout:

```
----- Display Test -----
21.Jan 2009      11:34

METTLER TOLEDO





Balance Type      MS204S
SNR               1234567890
SW               V1.00
Display Test      DONE
-----
```

18.3 Key Test

The key test allows you to test the keys of the balance.

- Press «←↓» to start "KEYPAD T".
- The message "KEY TEST - PRESS KEY TO BE TESTED" is displayed scrolling during the duration of the key test. Press every Key briefly. Each press of a key beeps and echoes with "OK" on the display.
- Second press «C» key to print the test information. The test procedure will be cancelled and the balance will return to the topic "DIAGNOSE". If a key has not been tested before printing, then the test results will be indicated with a "----" line.

Sample Information Displayed:

Key	Display
«  »	1/10 D OK
«  »	MENU OK
«  »	CAL OK
«  »	PRINT OK
«←»	MINUS OK
«+»	PLUS OK
«  »	TOGGLE OK
«←↓»	ENTER OK
«C»	C OK
«→0/T←»	O/T OK

Sample Printout:

```
----- Key Test -----  
21.Jan 2009          11:34  
  
METTLER TOLEDO  
  
Balance Type      MS204S  
SNR              1234567890  
SW              V1.00  
1/10 d Key      OK  
Menu Key        OK  
Cal Key         OK  
Print Key       OK  
Minus Key       OK  
Plus Key        OK  
Toggle Key      OK  
Enter Key       OK  
Zero/Tare Key   OK  
Cancel Key      OK  
-----
```

18.4 Motor Test

The motor test allows you to test the calibration motor of the balance.

Note: On models with internal weight only.

- a) Press «←|» to start "CAL.MOT. T".
"RUNNING" is displayed during the Motor Test. A motor test is deemed successful when all the motor positions have been successfully tested. At the end of the test, the test information will be printed.
- b) Press «≡|» for printout.
- c) Press «C» to cancel the test procedure. The balance will return to the topic "DIAGNOSE".

Sample Printout:

```
----- Motor Test -----  
21.Jan 2009          11:34  
  
METTLER TOLEDO  
  
Balance Type      MS204S  
SNR              1234567890  
SW              V1.00  
Motor Test       OK  
-----
```

18.5 Balance History

The balance history function allows you to view and print the history of the balance.

- a) Press «←|» to start "BAL.HIST".
- b) Press «≡|» for printout.
- c) Press «←|» to scroll forward through the displayed list of balance history information.
- d) Press «C» to cancel the test procedure. The balance will return to the topic "DIAGNOSE".

Sample Information Displayed:

Information	Display
Operation Time (year:day:hour)	00:018:04
Total load kg	115.7191 kg
Number of weighings	1255
Number of key pressed	4931
Number of motor movements	1012
Backlight time (year:day:hour)	00:018:04
Next service due date	01:01:2010

Sample Printout:

```

--- Statistical Info ---
21.Jan 2009      11:34

METTLER TOLEDO

Balance Type      MS4002S
SNR               1234567890
SW               V1.00
-----
Operating time
                  18d 4h
Total weight loaded
                  115.7191 kg
Number of weighings
                  1255
Number of key presses
                  4931
Motor movements
                  1012
Backlight operating time
                  18d 4h
Next service due date
                  01.01.2010
-----

```

18.6 Calibration History

The "Calibration History" function allows you to view and print information of the last 30 (thirty) balance adjustment. Adjustments made by a service technician and normal user are counted together.

- Press «←|» to start "CAL.HIST".
- Press «» for printout.
- Press «←|» key to scroll forward through the displayed list of Adjustments history information.
- Press «C» to cancel the test procedure. The balance will return to the topic "DIAGNOSE".

Sample Information Displayed:

Note	Display	
S = External adjusted service	05:03:09S	01
	-3 PPM	
F = FACT	05:03:09F	02
	2 PPM	
	.	.
	.	.
	.	.
I = Internal adjusted	04:03:09I	28

Note	Display	
I = Internal adjusted	-1 PPM	28
E = External adjusted user	03:03:09E	29
	4 PPM	
F = FACT	02:03:09F	30
	1 PPM	

Sample Printout:

```

----- Calibration -----
05.Mar 2009      11:34

METTLER TOLEDO

Balance Type      MS204S
SNR               1234567890
SW                1.50
-----
01 05.Mar 2009   11:34
External ADJ SERVICE
                23.5°C
Diff            -3ppm
-----
02 05.Mar 2009   09:00
FACT
                22.4°C
Diff            2ppm
-----
.
.
.
28 03.Mar 2009   10:59
Internal ADJ
                22.6°C
Diff            -1ppm
-----
29 02.Mar 2009   16:34
External ADJ USER
                24.6°C
Diff            4ppm
-----
30 02.Mar 2009   18:36
FACT
                22.4°C
Diff            1ppm
-----

```

18.7 Balance Information

The balance information function allows you to view and print information about your balance.

- Press «←|» to start "BAL.INFO".
- Press «» for printout.
- Press «←|» to scroll forward through the displayed list of Balance information.
- Press «C» to cancel the test procedure. The balance will return to the topic "DIAGNOSE".

Sample information displayed:

Information	Display
Balance type	TYPE MS6002S

Information	Display
Max. load	MAX 6200 g
Software platform	PLATFORM RAINBOW
Serial number	SNR 1234567890
Type definition number	TDNR 9.6.3.411
Software version	SOFTWARE V1.00
Cell ID	CELL ID 1172400044
Cell type	CELL TYPE MMAI6000G2
Tolerance revision number	TOLERANCE NO2
Language	LANGUAGE ENGLISH

Sample Printout:

```

-- Balance Information -
05.Mar 2009      11:34



METTLER TOLEDO

Balance Type      MS6002S
SNR               1234567890
SW               V1.00
Max              6200 g
Platform         Rainbow
TDNR            9.6.3.411.2-03
Cell ID         1172400044
Cell Type       MMAI6000G2
Tolerance Rev. no.  2
Language        English
-----

```

18.8 Service Provider Information

The service provider Information function allows you to print information about your service provider.

- a) Press «» to start "PROVIDER". The service provider information will be displayed.
- b) Press «». The service provider information will be printed and the balance will return to the topic "DIAG-NOSE".

Sample Printout:

```

--- Service Provider ---
21.Jan 2009      11:34

METTLER TOLEDO
Im Langacher
CH-8606 Greifensee
Switzerland
(+41) 044 944 22 11
-----

```

19 Communication with Peripheral Devices

19.1 Function PC-Direct

The numerical value displayed at the balance can be transferred to the cursor position in Windows Applications (e.g. Excel, Word) as by typing with the keyboard.

Note: The units will not be transferred.

Requirements

- PC with Microsoft Windows® operating system and serial interface RS232.
- Windows Application (e.g. Excel).
- Balance to PC connection with cable RS232 (e.g. No. 11101051 see chapter accessories).
- Balance Interface Setting (see Interface Menu):
 - Topic "RS232": set "PC-DIR." and select the most appropriate option for the desired weighing result.
 - Save changes.

Settings at the PC

Note: The following examples are based on Windows XP.



- a) Click "start".
- b) Click "ControlPanel".
- c) Click "Accessibility Options" in the Control Panel.

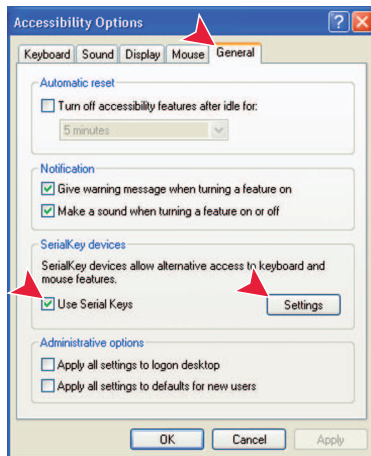

Accessibility Option

- a) Click "General" Tab.
- b) Enter a check mark at "Use Serial Keys".
- c) Click "Settings".

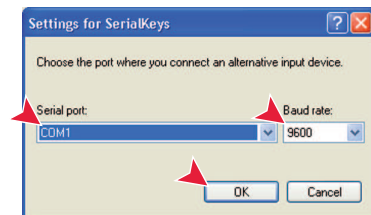

Settings for SerialKeys

- a) Select the serial port to be used for connection with the balance.
- b) Set the baud rate to 9600
- c) Click "OK".

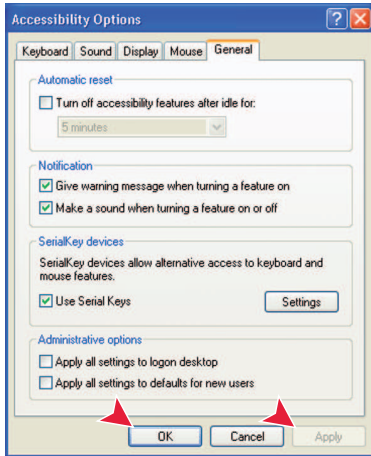

Complete the settings

- a) Click "Apply" when active (wait until active).
- b) Click "OK" .

Note: If the "serial key" is enabled, applications that use the same port may not function correctly. Remove the check mark from the check box "Use Serial Keys" to disable serial key function.

Checking Operation

- a) Start Excel (or another application) at the PC.
- b) Activate a cell in Excel.

According to your selected "PC-DIR." option, the displayed values will appear in the column one after the other one in the different rows.

19.2 Installing USB Device Interface

To perform the functionality "HOST" with a PC equipped only with a USB Interface, you have to assign an appropriate USB Driver on the PC first. You can find the "NewClassic Balance USB Installer" on the METTLER-TOLEDO website at the following address:

www.mt.com/newclassic

Requirements

- Balance with USB Device Interface.
- PC with Microsoft Windows® operating system (Version , XP SP2 or Vista 32).
- Internet connection and web browser (e.g. MS Internet Explorer).
- PC to balance USB connection cable.

Installing the "NewClassic Balance USB Installer" on the PC.

- a) Connect to the Internet.
- b) Go to the site "www.mt.com/newclassic".
- c) Click "Support" tab on the NewClassic Balance Site.
- d) Click "Download Center"
- e) Click "USB Driver"

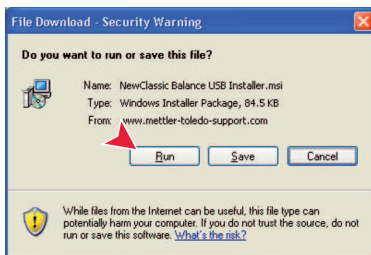

Install "NewClassic Balance USB Installer.msi"

- a) Click "Run" to install (recommended) or
- b) Click "Save" to download.

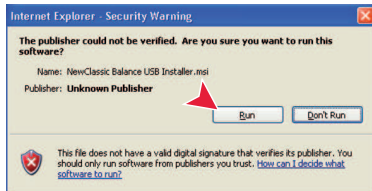

– Click "Run".

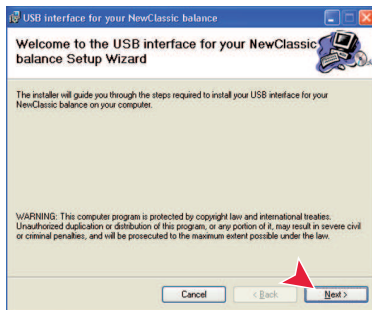

– Click "Next" and follow the Installer's instructions.



Install your Balance

- Switch the Balance "off".
- Connect the Balance to the preferred USB Port on the PC.
- Switch the Balance "on".
- Follow the instructions of the Wizard and install the Software automatically (recommended)

Note: The Wizard appears again for each USB port, either on your PC or if another balance is connected.

Warning: Do not click "Cancel" as for the connected USB port, it might not be possible anymore to perform the installation process.

20 Firmware (Software) Updates

METTLER TOLEDO is continuously improving its balance firmware (software) for the benefit of customers. So that the customer can benefit quickly and easily from further developments, METTLER TOLEDO makes the latest firmware versions available on the Internet. The firmware made available on the Internet has been developed and tested by Mettler-Toledo AG using processes that meet the guidelines of ISO 9001. Mettler-Toledo AG does not, however, accept liability for consequences that might arise from using the firmware.

20.1 Operating Principle

You will find all the relevant information and updates for your balance on the METTLER TOLEDO website at the following address:

www.mettler-toledo-support.com

A program known as the "**e-Loader II**" is loaded onto your computer together with the firmware update. You can use this program to download the firmware to the balance. The "e-Loader II" can also save the settings in your balance before the new firmware is downloaded to it. You can reload the saved settings into the balance manually or automatically after the software is downloaded.

If the selected update includes an application that is not described in these instructions (or that has been updated in the meantime) you can download the corresponding instructions in Adobe Acrobat® PDF format.

Requirements

The minimum requirements for obtaining applications from the Internet and downloading them into your balance are as follows:

- PC with Microsoft Windows® operating system (Version 98, 98SE, ME, NT4.0, 2000, XP or Vista).
- Internet connection and web browser (e.g. MS Internet Explorer).
- PC to balance connection cable (e.g. No. 11101051 see chapter accessories)

20.2 Update Procedure

Installing the "e-Loader II" software from the Internet onto the PC.

- a) Connect to the Internet.
- b) Go to the site "**www.mettler-toledo-support.com**".
- c) Enter the information required for registration on the METTLER TOLEDO Balance Support Site.
- d) Click the "Customer Support" link and log in.
- e) Click your Balance.
- f) Click the firmware version you need and install it.



Loading the new firmware into the balance.

- Start the "e-Loader II" and follow the instructions, which will take you step-by-step through the installation.

21 Error and Status Messages

21.1 Error Messages

Error messages in the display draw your attention to incorrect operation or that the balance could not execute a procedure properly.

Error Message	Cause	Rectification
NO STABILITY	No stability.	Ensure more stable ambient conditions. If not possible, check settings for environment.
WRONG ADJUSTMENT WEIGHT	Wrong adjustment weight on pan or none at all.	Place required adjustment weight in center of pan.
REFERENCE TOO SMALL	Reference for piece counting too small.	Increase reference weight.
EEPROM ERROR - PLEASE CONTACT CUSTOMER SERVICE	EEPROM (memory) error.	Please contact METTLER TOLEDO customer service.
WRONG CELL DATA - PLEASE CONTACT CUSTOMER SERVICE	Wrong cell data.	Please contact METTLER TOLEDO customer service.
NO STANDARD ADJUSTMENT - PLEASE CONTACT CUSTOMER SERVICE	No standard calibration.	Please contact METTLER TOLEDO customer service.
PROGRAM MEMORY DEFECT - PLEASE CONTACT CUSTOMER SERVICE	Program memory defect.	Please contact METTLER TOLEDO customer service.
TEMP SENSOR DEFECT - PLEASE CONTACT CUSTOMER SERVICE	Temperature sensor defect.	Please contact METTLER TOLEDO customer service.
WRONG LOAD CELL BRAND - PLEASE CONTACT CUSTOMER SERVICE	Wrong load cell brand.	Please contact METTLER TOLEDO customer service.
WRONG TYPE DATA SET - PLEASE CONTACT CUSTOMER SERVICE	Wrong type data set.	Please contact METTLER TOLEDO customer service.
BATTERY BACKUP LOST - CHECK DATE TIME SETTINGS	Backup battery is empty. This battery ensures that the date and time are not lost when the balance is disconnected from power.	Connect the balance to the power supply for charging the battery (e.g. during the night) or contact METTLER TOLEDO customer service.
	Overload - The weight on the pan exceeds the weighing capacity of the balance.	Reduce the weight on the weighing pan.
	Underload	Check that the weighing pan is positioned correctly.
INITIAL ZERO RANGE EXCEEDED	Wrong weighing pan or pan is not empty.	Mount correct weighing pan or unload weighing pan.
BELOW INITIAL ZERO RANGE	Wrong weighing pan or pan is missing.	Mount correct weighing pan.
MEM FULL	Memory full.	Clear the memory and start a new evaluation.
FACTOR OUT OF RANGE	Factor is outside the allow range.	Select a new factor.
STEP OUT OF RANGE	Step is outside the allow range.	Select a new step.
OUT OF RANGE	Sample weight is outside the allow range.	Unload the pan and load a new sample weight.

21.2 Status Messages

Status messages are displayed by means of small icons. The status icons indicate the following:

Status Icon	Signification
	Service Reminder Your balance is due for servicing. Contact your dealer's customer service department as soon as possible to have a technician service your balance. (See menu topic "SERV.ICON")

22 Cleaning and Service

Every now and then, clean the weighing pan, draft shield element, bottom plate, draft shield (depending on the model) and housing of your balance. Your balance is made from high-quality, durable materials and can therefore be cleaned using a damp cloth or with a standard cleaning agent.

To thoroughly clean the draft shield glass panels, remove the draft shield from the balance. When reinstalling the draft shield, ensure that it is in the correct position.

Please observe the following notes:



- The balance must be disconnected from the power supply
- Ensure that no liquid comes into contact with the balance or the AC adapter.
- Never open the balance or AC adapter – they contain no components, which can be cleaned, repaired or replaced by the user.



- On no account use cleaning agents which contain solvents or abrasive ingredients, as this can result in damage to the operation panel overlay.



- Do not clean the IP65 protected models using high-pressure or high-temperature water.

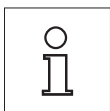

Please contact your METTLER TOLEDO dealer for details of the available service options. Regular servicing by an authorized service engineer ensures constant accuracy for years to come and prolongs the service life of your balance.

22.1 Cleaning the Glass Draft Shield (0.1 mg and 1 mg Models)

1 Remove the following parts:

- a) Remove weighing pan, draft shield element (0.1 mg models) and pan support.
- b) Remove the bottom plate.
- c) Unlock the draft shield, lift it off the balance and place it on a clean surface.

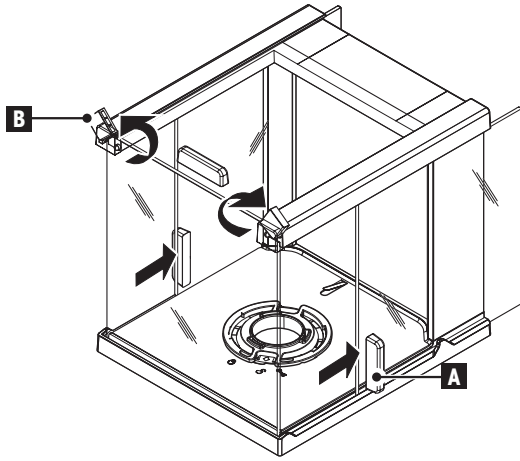

2

- a) Push the **glass doors (A)** back.
- b) Turn the two **lock covers (B)** on the front as far as they will go.

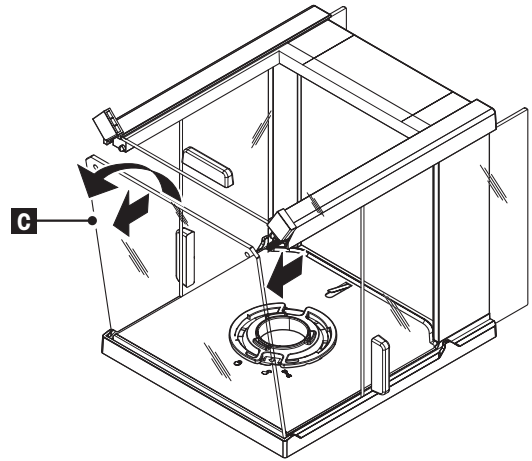

3

- a) Tilt the **front glass (C)** forward.
- b) Remove the front glass.

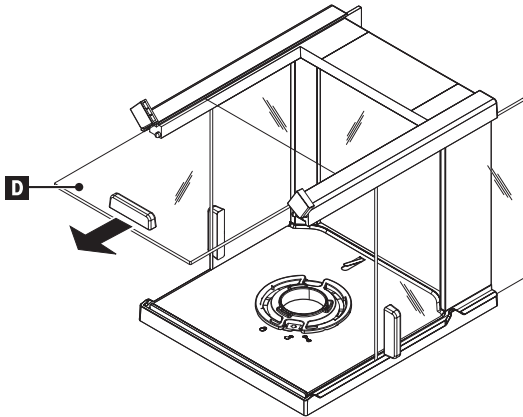

4

- Pull the **top glass door (D)** out from the front.

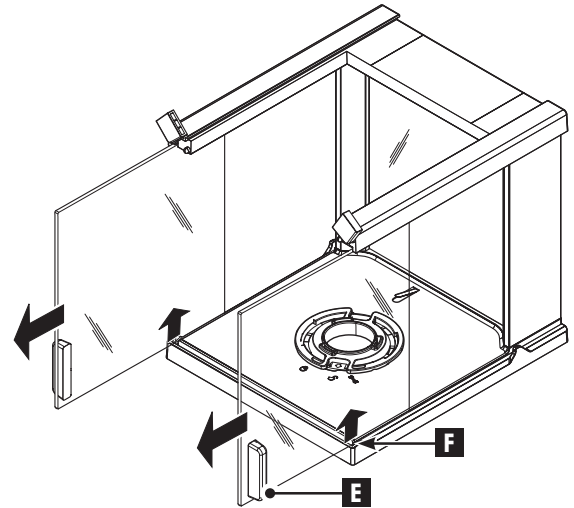

5

- Lift the **side glass doors (E)** at (F) and pull them out from the front.

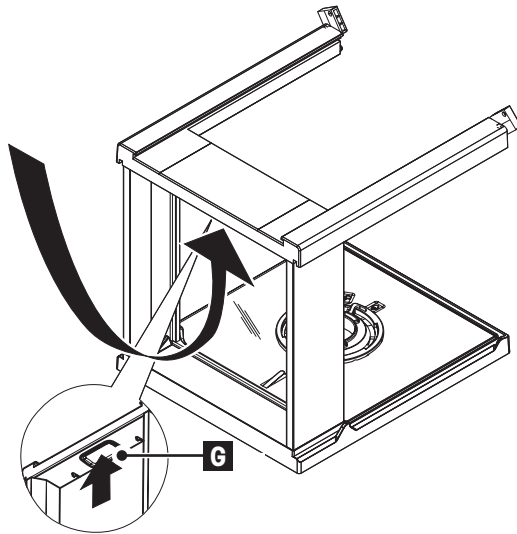

6

- Push the lock button (**G**) to release the **rear glass**.

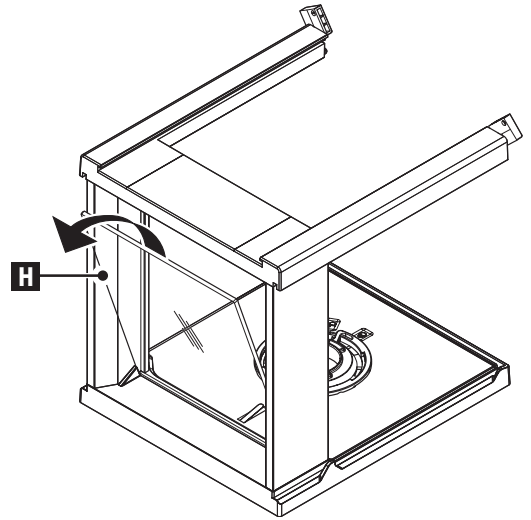

7

- Remove the rear glass (**H**).

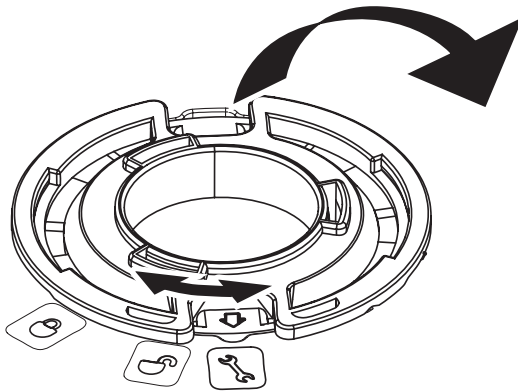

8

- Turn the **draft shield lock** to the "🔑" (Service) position.
- Remove the draft shield lock.

9

After cleaning reinstall all components in the reverse order. For balance mounting see chapter "Setting up the Balance – Installing the Components".

23 Interface Specification

23.1 RS232C Interface

Each balance is equipped with an RS232C Interface as standard for the attachment of a peripheral device (e.g. printer or computer).

Schematic	Item	Specification
	Interface type	Voltage interface according to EIA RS-232C/DIN66020 CCITT V24/V.28)
	Max. cable length	15 m
	Signal level	Outputs: +5 V ... +15 V (RL = 3–7 kΩ) –5 V ... –15 V (RL = 3–7 kΩ) Inputs: +3 V ... +25 V –3 V ... –25 V
	Connector	Sub-D, 9-pole, female
	Operating mode	Full duplex
	Transmission mode	Bit-serial, asynchronous
	Transmission code	ASCII
	Baud rates	600, 1200, 2400, 4800, 9600, 19200, 38400 (software selectable)
	Bits/parity	7-bit/none, 7-bit/even, 7-bit/odd, 8-bit/none (software selectable)
	Stop bits	1 stop bit
	Handshake	None, XON/XOFF, RTS/CTS (software selectable)
	End-of-line	<CR><LF>, <CR>, <LF> (software selectable)
	Power supply for 2nd display	+ 12 V, max 40 mA (software selectable, 2nd display mode only)

23.2 USB Device Interface

Each balance is equipped with an "USB Device" Interface as standard for the attachment of a peripheral device (e.g. computer).

Note: This interface is not suitable to communicate with a Printer.

Schematic	Item	Specification										
<table border="1" style="margin-top: 10px;"> <tr> <td>1</td> <td>VBUS (+5 VDC)</td> </tr> <tr> <td>2</td> <td>D- (Data -)</td> </tr> <tr> <td>3</td> <td>D+ (Data +)</td> </tr> <tr> <td>4</td> <td>GND (Ground)</td> </tr> <tr> <td>Shield</td> <td>Shield</td> </tr> </table>	1	VBUS (+5 VDC)	2	D- (Data -)	3	D+ (Data +)	4	GND (Ground)	Shield	Shield	Standard	In conformity with USB Specification Revision 1.1
	1	VBUS (+5 VDC)										
	2	D- (Data -)										
	3	D+ (Data +)										
	4	GND (Ground)										
	Shield	Shield										
Speed	Full speed 12 Mbps (requires shielded cable)											
Function	CDC (Communication Device Class) serial port emulation											
Power usage	Suspended device: Max 10 mA											
Connector	Type B											

23.3 MT-SICS Interface Commands and Functions

Many of the balances and scales used have to be capable of integration in a complex computer or data acquisition system.

To enable you to integrate balances in your system in a simple manner and utilize their capabilities to the full, most balance functions are also available as appropriate commands via the data interface.

All new METTLER TOLEDO balances launched on the market support the standardized command set "METTLER TOLEDO Standard Interface Command Set" (MT-SICS). The commands available depending on the functionality of the balance.

Basic information on data interchange with the balance

The balance receives commands from the system and acknowledges the command with an appropriate response.

Command formats

Commands sent to the balance comprise one or more characters of the ASCII character set. Here, the following must be noted:

- Enter commands only in uppercase.
- The possible parameters of the command must be separated from one another and from the command name by a space (ASCII 32 dec., in this description represented as `␣`).
- The possible input for "text" is a sequence of characters of the 8-bit ASCII character set from 32 dec to 255 dec.
- Each command must be closed by `CRLF` (ASCII 13 dec., 10 dec.). The characters `CRLF`, which can be inputted using the Enter or Return key of most entry keypads, are not listed in this description, but it is essential they be included for communication with the balance.

Example

S – Send stable weight value

Command	<code>S</code>	Get the current stable net weight value.
Response	<code>S␣S␣WeightValue␣Unit</code>	Current stable weight value in unit actually set under unit 1.
	<code>S␣I</code>	Command not executable (balance is currently executing another command, e.g. taring, or timeout as stability was not reached).
	<code>S␣+</code>	Balance in overload range.
	<code>S␣-</code>	Balance in underload range.

Example

Command	<code>S</code>	Query a stable weight value.
Response	<code>S␣S␣␣␣␣␣100.00␣g</code>	The current stable weight value is 100.00 g.

The available MT-SICS commands are listed in the table (depending on the model). For further information please refer to the Reference Manual "MT-SICS 11780711" downloadable from the Internet under www.mt.com/sics-newclassic.



	Description		Description
@	Cancel (Reset)	M46	Print interval
C0	Query/Set adjustment settings	PW	Piece counting: Query/Set piece weight
C1	Start adjustment according to current settings	PWR	Power on/off (PWR 0 means switch off completely, if balance is powered by battery)
C2	Start adjustment with external weight	S	Send stable weight value
C3	Start adjustment with internal weight	SI	Send weight value immediately
D	Display text sent to balance	SIR	Send weight value immediately and repeat
DAT	Date query/set	SIRU	Send weight value with currently displayed unit immediately and repeat
DW	Display weight	SIU	Send weight value with currently displayed unit immediately
I0	Commands implemented	SM0	Dynamic weighing: cancel all SMx commands
I1	MT-SICS level and MT-SICS versions	SM1	Dynamic weighing: Start immediately and send the result
I2	Balance data	SM2	Dynamic weighing: start after a minimum load is exceeded and send result

	Description		Description
I3	Software version, type definition number	SM3	Dynamic weighing: start after a minimum load is exceeded, send result and repeat
I4	Query serial number (SNR)	SM4	Dynamic weighing: query/set time interval
I5	Query SW-identification number	SNR	Send stable weight value and repeat on weight change
I10	Query/set balance ID	SNRU	Send stable weight value with currently displayed unit and repeat on weight change
I11	Query balance type	SR	Send weight value on weight change
I14	Query balance information	SRU	Send stable weight value with currently displayed unit on weight change
K	Keys: set configuration	ST	Send stable weight value on pressing (print) key
M02	Query/set environment	SU	Send stable weight value with currently displayed unit
M03	Query/set AutoZero	T	Tare
M08	Display brightness	TA	Get/Set tare weight value
M09	Display contrast	TAC	Clear tare value
M11	Beeper: Query/set volume	TI	Tare immediately
M14	List available language	TIM	Query/set time
M15	Query/set language	TST0	Query/set test function settings
M17	FACT: query/set single time criteria (no possibility to set "weekday")	TST1	Start test function according to current settings
M22	Custom unit definition Remarks: no possibility to set "name" of unit	TST2	Start test function with external weight
M25	Get application list	TST3	Start test function with internal weight
M26	Get/set current application	UPD	Query/set update rate of the host interface
M27	Adjustment history	Z	Zero
M30	+/- settings with nominal and tolerance	ZI	Zero immediately

24 Technical Data

24.1 General Data

Power Supply

- S Platform: AC/DC Adapter
Primary: 100V–240V, 50/60Hz, 0.3 A
Secondary: 12VDC, 0.84A (with electronic overload protection)
Power supply to the balance: 11–20VDC, 10W
 Use only with a tested AC Adapter with SELV output current.
Ensure correct polarity 
- L Platform: Power supply 100V–240V, 50/60Hz, 0.3 A
Power cable 2-core with country-specific plug
MS-KL models: Built-in rechargeable NiMH battery (nickel-metal hydride)

Protection and Standards

- Overvoltage category: Class II, III
- Degree of pollution: 2
- Degree of Protection: Protected against dust and water
Models with S + L Platform: IP54 in use with weighing pan
MS-KLIP models: IP65
- Standards for safety and EMC: See Declaration of Conformity
- Range of application: For use only in enclosed interior rooms

Environmental conditions

- Height above mean sea level: up to 4000 m
- Ambient temperature range: 10 to 30 °C (S platform)
5 to 40 °C (L platform)
- Relative air humidity: 10% to 80 % at 31 °C, linearly decreasing to 50 % at 40 °C, non-condensing

Materials

- Housing: Die-cast aluminum, lacquered
- Weighing pan: Stainless steel X2CrNiMo 17-12-2 (1.4404)
245 x 351 mm: Stainless steel X5CrNiMo 18-10 (1.4301)
- Draft shield element: with 0.1 mg models: Stainless steel X2CrNiMo 17-12-2 (1.4404)
with 10 mg models: Plastic (PBT)
- Draft shield: Plastic (PBT), glass
- In-use-cover: Plastic (PET)

24.2 Model-Specific Data

24.2.1 Balances with Readability of 0.1 mg, S Platform with Draft Shield

Technical Data

Model	MS104S	MS204S	MS304S
Maximum load	120 g	220 g	320 g
Maximum load, fine range	–	–	–
Readability	0.1 mg	0.1 mg	0.1 mg
Readability, fine range	–	–	–
Taring range	0...120 g	0...220 g	0...320 g
Repeatability (sd)	0.1 mg	0.1 mg	0.1 mg

Model	MS104S	MS204S	MS304S
Repeatability (sd), fine range	–	–	–
Linearity	0.2 mg	0.2 mg	0.3 mg
Linearity, fine range	–	–	–
Sensitivity temperature drift (10...30°C)	1.5 ppm/°C	1.5 ppm/°C	1.5 ppm/°C
Internal adjustment	yes, FACT	yes, FACT	yes, FACT
Adjustment range with external weights	50...120 g	100...220 g	100...320 g
Weights for routine testing			
Large Weight/Class OIML/ASTM	100 g / F2/4	200 g / F2/4	200 g / F2/4
Small Weight/Class OIML/ASTM	5 g / E2/2	10 g / F1/3	10 g / F1/3
Minimum weight (acc. to USP)	0.3 g	0.3 g	0.3 g
Minimum weight (U=1%, k=2)	0.02 g	0.02 g	0.02 g
Minimum weight (OIML)	0.01 g	0.01 g	0.01 g
Settling time, typ.	2 s	2 s	3 s
Weighing technology	MonoBloc	MonoBloc	MonoBloc
Usable height of draft shield [mm]	236	236	236
Weighing pan dimensions (WxD) [mm]	Ø 90	Ø 90	Ø 90
Balance dimensions (WxDxH) [mm]	204x347x348	204x347x348	204x347x348
Net Weight [kg]	6.5	6.5	6.5

24.2.2 Balances with Readability of 1 mg, S Platform with Draft Shield

Technical Data

Model	MS303S	MS303SE	MS403S
Maximum load	320 g	320 g	420 g
Maximum load, fine range	–	–	–
Readability	0.001 g	0.001 g	0.001 g
Readability, fine range	–	–	–
Taring range	0...320 g	0...320 g	0...420 g
Repeatability (sd)	0.001 g	0.001 g	0.001 g
Repeatability (sd), fine range	–	–	–
Linearity	0.002 g	0.002 g	0.002 g
Linearity, fine range	–	–	–
Sensitivity temperature drift (10...30°C)	3 ppm/°C	3 ppm/°C	3 ppm/°C
Internal adjustment	yes, FACT	no, EXT ADJ	yes, FACT
Adjustment range with external weights	100...320 g	100...320 g	100...420 g
Weights for routine testing			
Large Weight/Class OIML/ASTM	200 g / F2/4	200 g / F2/4	200 g / F2/4
Small Weight/Class OIML/ASTM	10 g / F1/3	10 g / F1/3	20 g / F1/3
Minimum weight (acc. to USP)	3 g	3 g	3 g
Minimum weight (U=1%, k=2)	0.2 g	0.2 g	0.2 g
Minimum weight (OIML)	0.02 g	0.02 g	0.02 g
Settling time, typ.	1.5 s	1.5 s	1.5 s
Weighing technology	MonoBloc	MonoBloc	MonoBloc
Usable height of draft shield [mm]	168	168	168
Weighing pan dimensions (WxD) [mm]	127x127	127x127	127x127
Balance dimensions (WxDxH) [mm]	204x347x283	204x347x283	204x347x283
Net Weight [kg]	6.2	6.2	6.2

Model	MS603S	MS1003S
Maximum load	620 g	1020 g
Maximum load, fine range	–	–
Readability	0.001 g	0.001 g

Model	MS603S	MS1003S
Readability, fine range	–	–
Taring range	0...620 g	0...1020 g
Repeatability (sd)	0.001 g	0.001 g
Repeatability (sd), fine range	–	–
Linearity	0.002 g	0.002 g
Linearity, fine range	–	–
Sensitivity temperature drift (10...30°C)	3 ppm/°C	3 ppm/°C
Internal adjustment	yes, FACT	yes, FACT
Adjustment range with external weights	100...620 g	500...1020 g
Weights for routine testing		
Large Weight/Class OIML/ASTM	500 g / F2/4	1000 g / F2/4
Small Weight/Class OIML/ASTM	20 g / F1/3	50 g / F2/4
Minimum weight (acc. to USP)	3 g	3 g
Minimum weight (U=1%, k=2)	0.2 g	0.2 g
Minimum weight (OIML)	0.02 g	0.1 g
Settling time, typ.	1.5 s	1.5 s
Weighing technology	MonoBloc	MonoBloc
Usable height of draft shield [mm]	168	168
Weighing pan dimensions (WxD) [mm]	127x127	127x127
Balance dimensions (WxDxH) [mm]	204x347x283	204x347x283
Net Weight [kg]	6.2	6.9

24.2.3 Balances with Readability of 0.01 g, S Platform

Technical Data

Model	MS802S*	MS1602S	MS1602SE
Maximum load	820 g	1620 g	1620 g
Maximum load, fine range	–	–	–
Readability	0.01 g	0.01 g	0.01 g
Readability, fine range	–	–	–
Taring range	0...820 g	0...1620 g	0...1620 g
Repeatability (sd)	0.01 g	0.01 g	0.01 g
Repeatability (sd), fine range	–	–	–
Linearity	0.02 g	0.02 g	0.02 g
Linearity, fine range	–	–	–
Sensitivity temperature drift (10...30°C)	3 ppm/°C	3 ppm/°C	3 ppm/°C
Internal adjustment	yes, FACT	yes, FACT	no, EXT ADJ
Adjustment range with external weights	100...820 g	1000...1620 g	1000...1620 g
Weights for routine testing			
Large Weight/Class OIML/ASTM	500 g / F2/4	1000 g / F2/4	1000 g / F2/4
Small Weight/Class OIML/ASTM	20 g / F2/4	50 g / F2/4	50 g / F2/4
Minimum weight (acc. to USP)	30 g	30 g	30 g
Minimum weight (U=1%, k=2)	2 g	2 g	2 g
Minimum weight (OIML)	0.5 g	0.5 g	0.5 g
Settling time, typ.	1.5 s	1.5 s	1.5 s
Weighing technology	MonoBloc	MonoBloc	MonoBloc
Weighing pan dimensions (WxD) [mm]	170x200	170x200	170x200
Balance dimensions (WxDxH) [mm]	194x347x99	194x347x99	194x347x99
Net Weight [kg]	5.5	5.5	5.5

* Only available in selected countries.

Model	MS3002S	MS3002SE	MS4002S
Maximum load	3200 g	3200 g	4200 g
Maximum load, fine range	–	–	–
Readability	0.01 g	0.01 g	0.01 g
Readability, fine range	–	–	–
Taring range	0...3200 g	0...3200 g	0...4200 g
Repeatability (sd)	0.01 g	0.01 g	0.01 g
Repeatability (sd), fine range	–	–	–
Linearity	0.02 g	0.02 g	0.02 g
Linearity, fine range	–	–	–
Sensitivity temperature drift (10...30°C)	3 ppm/°C	3 ppm/°C	3 ppm/°C
Internal adjustment	yes, FACT	no, EXT ADJ	yes, FACT
Adjustment range with external weights	1000...3200 g	1000...3200 g	1000...4200 g
Weights for routine testing			
Large Weight/Class OIML/ASTM	2000 g / F2/4	2000 g / F2/4	2000 g / F2/4
Small Weight/Class OIML/ASTM	100 g / F2/4	100 g / F2/4	200 g / F2/4
Minimum weight (acc. to USP)	30 g	30 g	30 g
Minimum weight (U=1%, k=2)	2 g	2 g	2 g
Minimum weight (OIML)	0.5 g	0.5 g	0.5 g
Settling time, typ.	1.5 s	1.5 s	1.5 s
Weighing technology	MonoBloc	MonoBloc	MonoBloc
Weighing pan dimensions (WxD) [mm]	170x200	170x200	170x200
Balance dimensions (WxDxH) [mm]	194x347x99	194x347x99	194x347x99
Net Weight [kg]	5.5	5.5	5.5

Model	MS4002SDR	MS6002S	MS6002SDR
Maximum load	4200 g	6200 g	6200 g
Maximum load, fine range	820 g	–	1220 g
Readability	0.1 g	0.01 g	0.1 g
Readability, fine range	0.01 g	–	0.01 g
Taring range	0...4200 g	0...6200 g	0...6200 g
Repeatability (sd)	0.06 g	0.01 g	0.06 g
Repeatability (sd), fine range	0.01	–	0.01 g
Linearity	0.2 g	0.02 g	0.2 g
Linearity, fine range	0.02 g	–	0.02 g
Sensitivity temperature drift (10...30°C)	3 ppm/°C	3 ppm/°C	3 ppm/°C
Internal adjustment	yes, FACT	yes, FACT	yes, FACT
Adjustment range with external weights	1000...4200 g	2000...6200 g	2000...6200 g
Weights for routine testing			
Large Weight/Class OIML/ASTM	2000 g / F2/4	5000 g / F2/4	5000 g / F2/4
Small Weight/Class OIML/ASTM	200 g / F2/4	200 g / F2/4	200 g / F2/4
Minimum weight (acc. to USP)	30 g	30 g	30 g
Minimum weight (U=1%, k=2)	2 g	2 g	2 g
Minimum weight (OIML)	0.5 g	0.5 g	0.5 g
Settling time, typ.	1.5 s	1.2 s	1.2 s
Weighing technology	MonoBloc	MonoBloc	MonoBloc
Weighing pan dimensions (WxD) [mm]	170x200	170x200	170x200
Balance dimensions (WxDxH) [mm]	194x347x99	194x347x99	194x347x99
Net Weight [kg]	5.5	5.3	5.3

24.2.4 Balances with Readability of 0.1 g to 1 g, S Platform

Technical Data

Model	MS3001S*	MS6001S	MS8001S
Maximum load	3200 g	6200 g	8200 g
Maximum load, fine range	–	–	–
Readability	0.1 g	0.1 g	0.1 g
Readability, fine range	–	–	–
Taring range	0...3200 g	0...6200 g	0...8200 g
Repeatability (sd)	0.1 g	0.1 g	0.1 g
Repeatability (sd), fine range	–	–	–
Linearity	0.2 g / 0.1 g ¹⁾	0.2 g	0.2 g
Linearity, fine range	–	–	–
Sensitivity temperature drift (10...30°C)	5 ppm/°C	5 ppm/°C	5 ppm/°C
Internal adjustment	yes, FACT	yes, FACT	yes, FACT
Adjustment range with external weights	1000...3200 g	2000...6200 g	2000...8200 g
Weights for routine testing			
Large Weight/Class OIML/ASTM	2000 g / F2/4	5000 g / F2/4	5000 g / F2/4
Small Weight/Class OIML/ASTM	100 g / F2/4	200 g / F2/4	200 g / F2/4
Minimum weight (acc. to USP)	30 g	300 g	300 g
Minimum weight (U=1 %, k=2)	20 g	20 g	20 g
Minimum weight (OIML)	5 g	5 g	5 g
Settling time, typ.	1 s	1 s	1 s
Weighing technology	MonoBloc	MonoBloc	MonoBloc
Weighing pan dimensions (WxD) [mm]	190x226	190x226	190x226
Balance dimensions (WxDxH) [mm]	194x347x99	194x347x99	194x347x99
Net Weight [kg]	5.6	5.6	5.6

* Only available in selected countries.

¹⁾ approved version (OIML)

Model	MS8001SE	MS8000S	MS8000SE
Maximum load	8200 g	8200 g	8200 g
Maximum load, fine range	–	–	–
Readability	0.1 g	1 g	1 g
Readability, fine range	–	–	–
Taring range	0...8200 g	0...8200 g	0...8200 g
Repeatability (sd)	0.1 g	1 g	1 g
Repeatability (sd), fine range	–	–	–
Linearity	0.2 g	2 g	2 g
Linearity, fine range	–	–	–
Sensitivity temperature drift (10...30°C)	15 ppm/°C	15 ppm/°C	15 ppm/°C
Internal adjustment	no, EXT ADJ	yes, FACT	no, EXT ADJ
Adjustment range with external weights	2000...8200 g	2000...8200 g	2000...8200 g
Weights for routine testing			
Large Weight/Class OIML/ASTM	5000 g / F2/4	5000 g / F2/4	5000 g / F2/4
Small Weight/Class OIML/ASTM	200 g / F2/4	200 g / F2/4	200 g / F2/4
Minimum weight (acc. to USP)	300 g	3000 g	3000 g
Minimum weight (U=1 %, k=2)	20 g	200 g	200 g
Minimum weight (OIML)	5 g	50 g	50 g
Settling time, typ.	1 s	1 s	1 s
Weighing technology	MonoBloc	MonoBloc	MonoBloc
Weighing pan dimensions (WxD) [mm]	190x226	190x226	190x226
Balance dimensions (WxDxH) [mm]	194x347x99	194x347x99	194x347x99

Model	MS8001SE	MS8000S	MS8000SE
Net Weight [kg]	5.6	5.6	5.6

24.2.5 Balances with Readability of 0.1 g to 1 g, L Platform

Technical Data

Model	MS12001L	MS16001L	MS16001LE
Maximum load	12200 g	16200 g	16200 g
Maximum load, fine range	–	–	–
Readability	0.1 g	0.1 g	0.1 g
Readability, fine range	–	–	–
Taring range	0...12200 g	0...16200 g	0...16200 g
Repeatability (sd)	0.1 g	0.1 g	0.1 g
Repeatability (sd), fine range	–	–	–
Linearity	0.2 g	0.2 g	0.2 g
Linearity, fine range	–	–	–
Sensitivity temperature drift (10...30°C)	5 ppm/°C	5 ppm/°C	15 ppm/°C
Internal adjustment	yes, FACT	yes, FACT	no, EXT ADJ
Adjustment range with external weights	5000...12200 g	5000...16200 g	5000...16200 g
Weights for routine testing			
Large Weight/Class OIML/ASTM	10000 g / F2/4	10000 g / F2/4	10000 g / F2/4
Small Weight/Class OIML/ASTM	500 g / F2/4	500 g / F2/4	500 g / F2/4
Minimum weight (acc. to USP)	300 g	300 g	300 g
Minimum weight (U=1%, k=2)	20 g	20 g	20 g
Minimum weight (OIML)	5 g	5 g	5 g
Settling time, typ.	2 s	2 s	2 s
Weighing technology	MonoBloc	MonoBloc	MonoBloc
Built-in battery	no	no	no
Weighing below the balance (with optional hook)	yes	yes	yes
Weighing pan dimensions (WxD) [mm]	351x245	351x245	351x245
Balance dimensions (WxDxH) [mm]	363x346x118	363x346x118	363x346x118
Net Weight [kg]	10.7	10.7	10.7

Model	MS32001L	MS32001LE
Maximum load	32200 g	32200 g
Maximum load, fine range	–	–
Readability	0.1 g	0.1 g
Readability, fine range	–	–
Taring range	0...32200 g	0...32200 g
Repeatability (sd)	0.1 g	0.1 g
Repeatability (sd), fine range	–	–
Linearity	0.3 g	0.3 g
Linearity, fine range	–	–
Sensitivity temperature drift (10...30°C)	5 ppm/°C	15 ppm/°C
Internal adjustment	yes, FACT	no, EXT ADJ
Adjustment range with external weights	10000...32200 g	10000...32200 g
Weights for routine testing		
Large Weight/Class OIML/ASTM	20000 g / F2/4	20000 g / F2/4
Small Weight/Class OIML/ASTM	1000 g / F2/4	1000 g / F2/4
Minimum weight (acc. to USP)	300 g	300 g
Minimum weight (U=1%, k=2)	20 g	20 g
Minimum weight (OIML)	5 g	5 g

Model	MS32001L	MS32001LE
Settling time, typ.	1.5 s	1.5 s
Weighing technology	MonoBloc	MonoBloc
Built-in battery	no	no
Weighing below the balance (with optional hook)	yes	yes
Weighing pan dimensions (WxD) [mm]	351x245	351x245
Balance dimensions (WxDxH) [mm]	363x346x118	363x346x118
Net Weight [kg]	10.7	10.7

Model	MS32000L	MS32000LE
Maximum load	32200 g	32200 g
Maximum load, fine range	–	–
Readability	1 g	1 g
Readability, fine range	–	–
Taring range	0...32200 g	0...32200 g
Repeatability (sd)	0.5 g	0.5 g
Repeatability (sd), fine range	–	–
Linearity	1 g	1 g
Linearity, fine range	–	–
Sensitivity temperature drift (10...30°C)	5 ppm/°C	15 ppm/°C
Internal adjustment	yes, FACT	no, EXT ADJ
Adjustment range with external weights	10000...32200 g	10000...32200 g
Weights for routine testing		
Large Weight/Class OIML/ASTM	20000 g / F2/4	20000 g / F2/4
Small Weight/Class OIML/ASTM	1000 g / F2/4	1000 g / F2/4
Minimum weight (acc. to USP)	1500 g	1500 g
Minimum weight (U=1%, k=2)	100 g	100g
Minimum weight (OIML)	50 g	50 g
Settling time, typ.	1.5 s	1.5 s
Weighing technology	MonoBloc	MonoBloc
Built-in battery	no	no
Weighing below the balance (with optional hook)	yes	yes
Weighing pan dimensions (WxD) [mm]	351x245	351x245
Balance dimensions (WxDxH) [mm]	363x346x118	363x346x118
Net Weight [kg]	10.7	10.6

24.2.6 Balances with Readability of 2 g to 5 g, L Platform

Technical Data

Model	MS15KLE	MS15KLIPE
Maximum load	15 kg	15 kg
Readability	2 g	2 g
Weighing range (approved version)	6 kg / 15 kg	6 kg / 15 kg
Readability (approved version)	2 g / 5 g	2 g / 5 g
Taring range	0...15 kg	0...15 kg
Repeatability (sd)	1 g	1 g
Linearity	2 g	2 g
Internal adjustment	no, EXT ADJT	no, EXT ADJ
Adjustment range with external weights	5...15 kg	5...15 kg

Model	MS15KLE	MS15KLIPE
Weights for routine testing		
Large Weight/Class OIML/ASTM	10 kg / F2/4	10 kg / F2/4
Small Weight/Class OIML/ASTM	500 g / F2/4	500 g / F2/4
Settling time, typ.	1 s	1 s
Weighing technology	Strain Gauge	Strain Gauge
Weighing pan dimensions (WxD) [mm]	351x245	351x245
Built-in battery	yes	yes
IP Protection	IP 54 in use	IP 65
Weighing below the balance (with optional hook)	no	no
Balance dimensions (WxDxH) [mm]	363x346x122	363x346x122
Net Weight [kg]	9.9	9.9

Model	MS24KLIPE	MS30KLE
Maximum load	24 kg	30 kg
Readability	2 g	2 g
Weighing range(approved version)	15 kg / 24 kg	15 kg / 30 kg
Readability(approved version)	5 g / 10 g	5 g / 10 g
Taring range	0...24 kg	0...30 kg
Repeatability (sd)	2 g	2 g
Linearity	2 g	2 g
Internal adjustment	no, EXT ADJT	no, EXT ADJ
Adjustment range with external weights	10...24 kg	10...30 kg
Weights for routine testing		
Large Weight/Class OIML/ASTM	20 kg / F2/4	20 kg / F2/4
Small Weight/Class OIML/ASTM	1000 g / F2/4	1000 g / F2/4
Settling time, typ.	1 s	1 s
Weighing technology	Strain Gauge	Strain Gauge
Weighing pan dimensions (WxD) [mm]	351x245	351x245
Built-in battery	yes	yes
IP Protection	IP 65	IP 54 in use
Weighing below the balance (with optional hook)	no	no
Balance dimensions (WxDxH) [mm]	363x346x122	363x346x122
Net Weight [kg]	9.9	9.9

24.3 Dimensions

24.3.1 Balances with Readability of 0.1 mg, S Platform With Draft Shield

Models:
MS104S
MS204S
MS304S

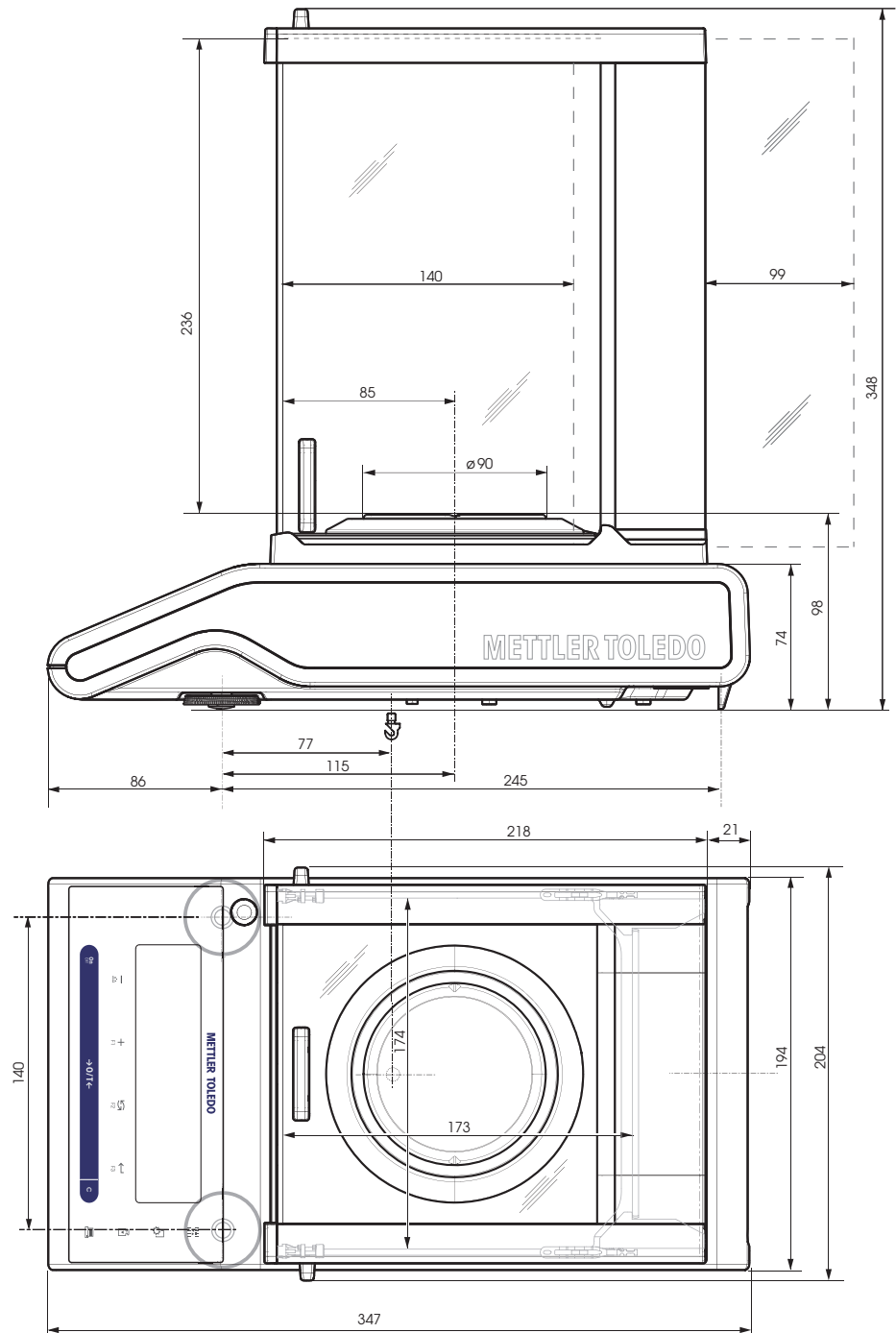

24.3.2 Balances with Readability of 1 mg, S Platform With Draft Shield

Models:
 MS303S
 MS303SE
 MS403S
 MS603S
 MS1003S

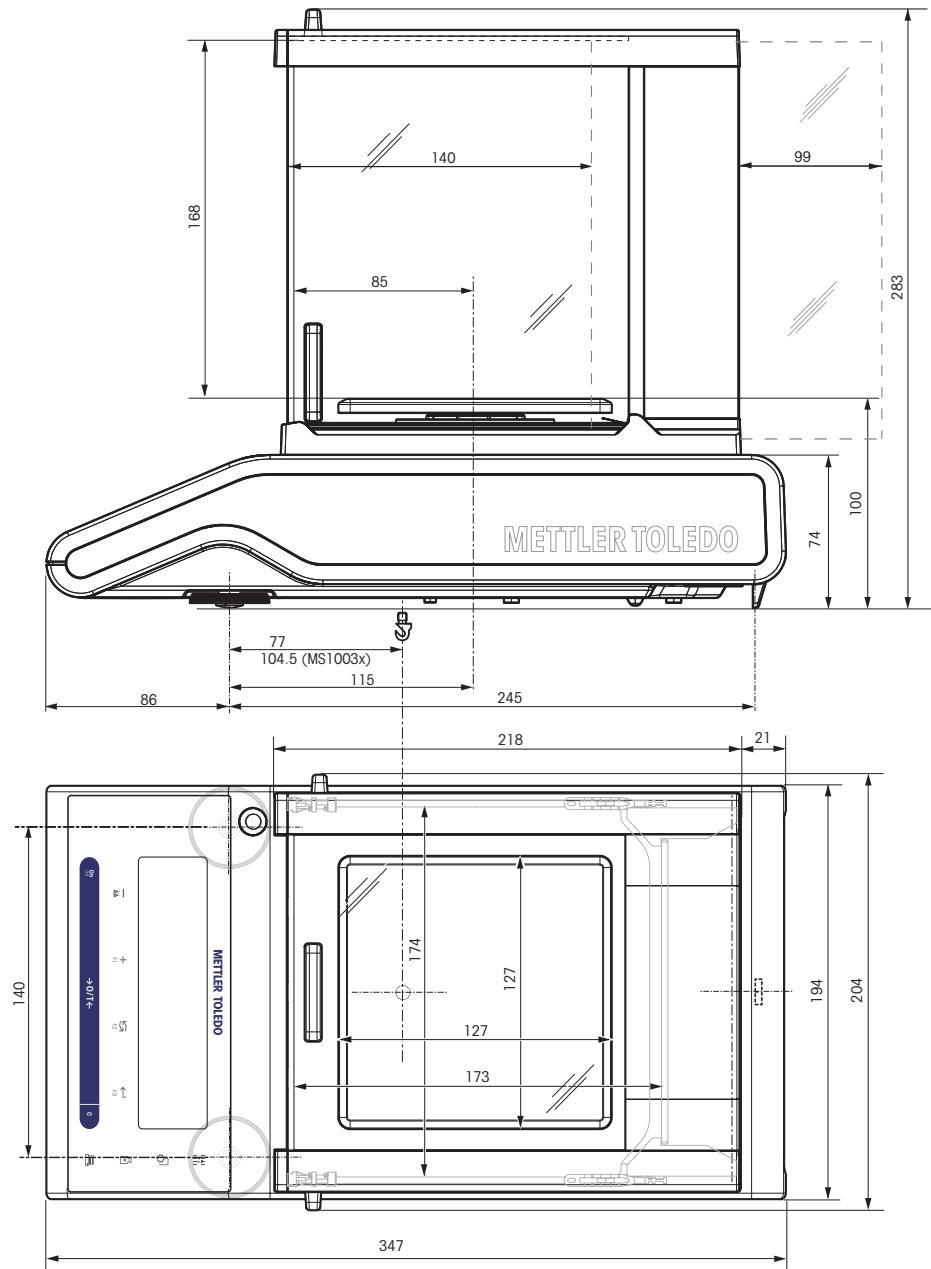

24.3.3 Balances with Readability of 0.01 g, S Platform

Models:

- MS802S
- MS1602S
- MS1602SE
- MS3002S
- MS3002SE
- MS4002S
- MS4002SDR
- MS6002S
- MS6002SDR

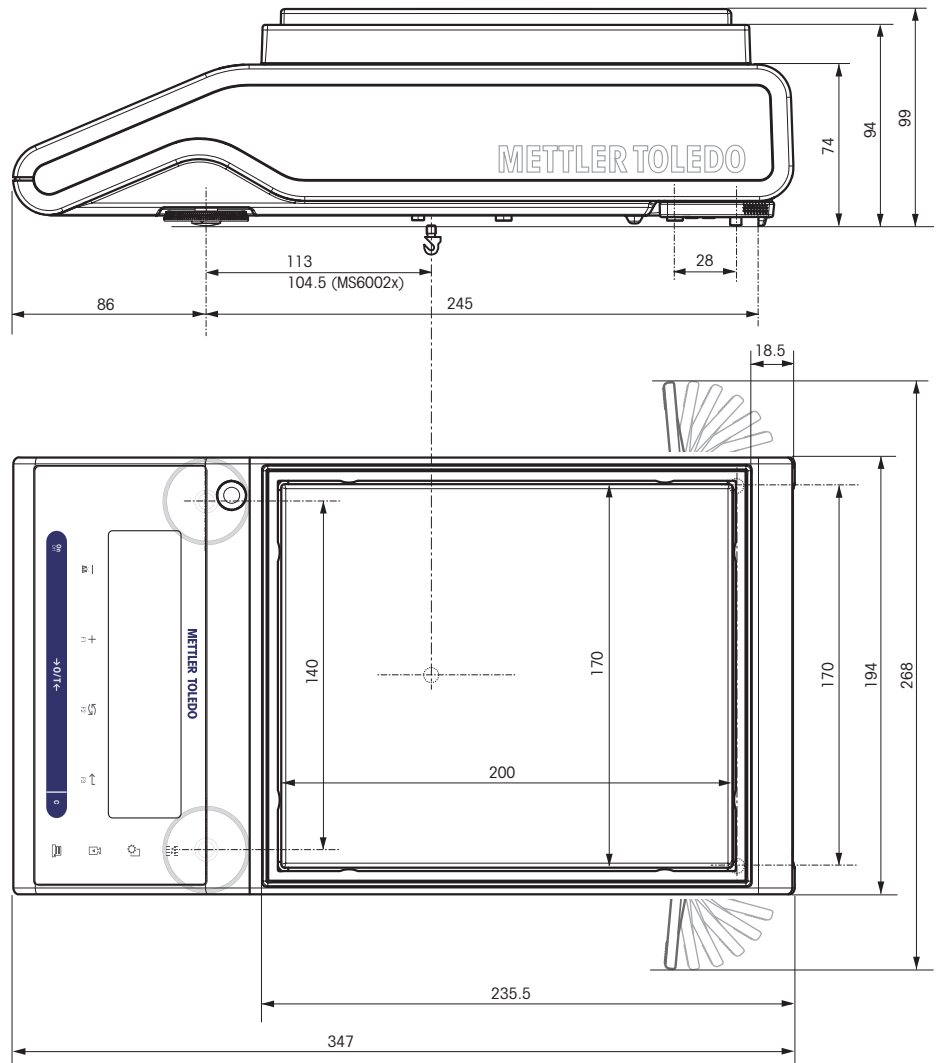

24.3.4 Balances with Readability of 0.1 g to 1 g, S Platform

Models:

- MS3001S
- MS6001S
- MS8001S
- MS8001SE
- MS8000S
- MS8000SE

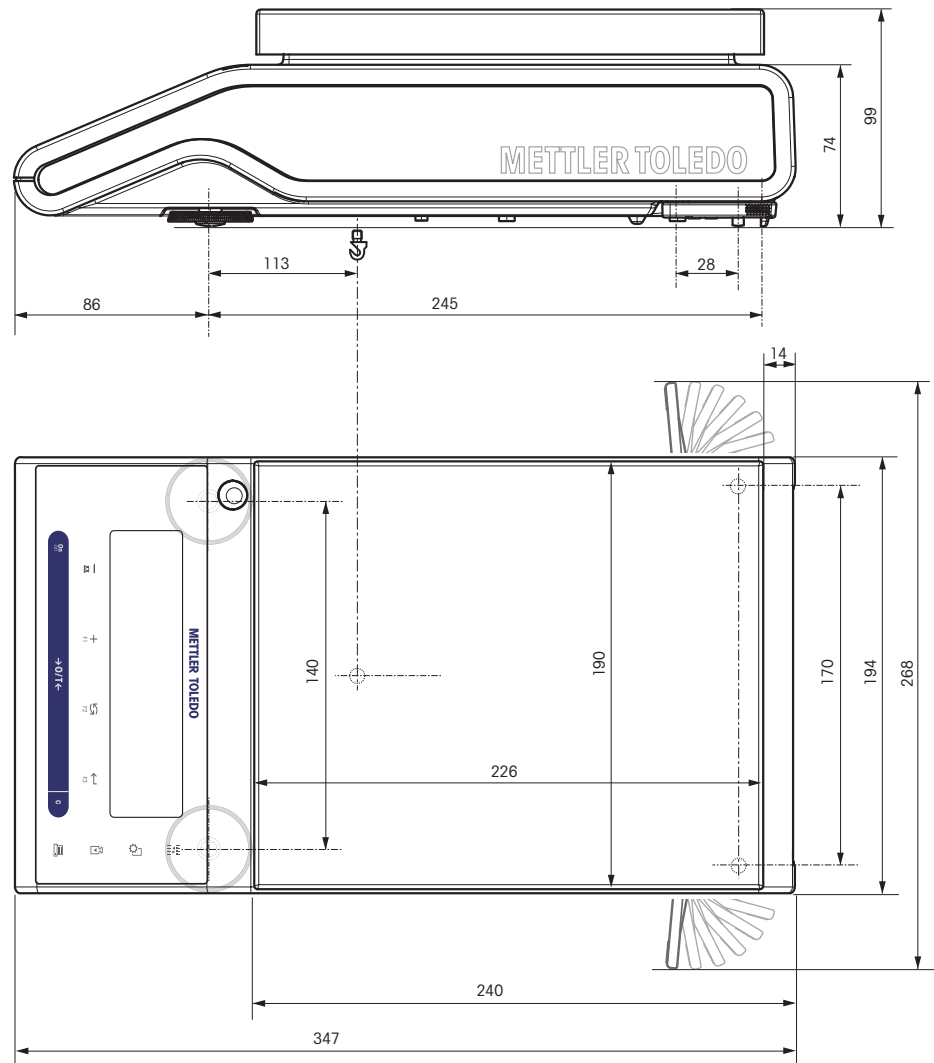

24.3.5 Balances with Readability of 0.1 g to 5 g, L Platform

Models:

- MS12001L
- MS16001L
- MS16001LE
- MS32001L
- MS32001LE
- MS32000L
- MS32000LE
- MS15KLE
- MS15KLIPE
- MS24KLIPE
- MS30KLE

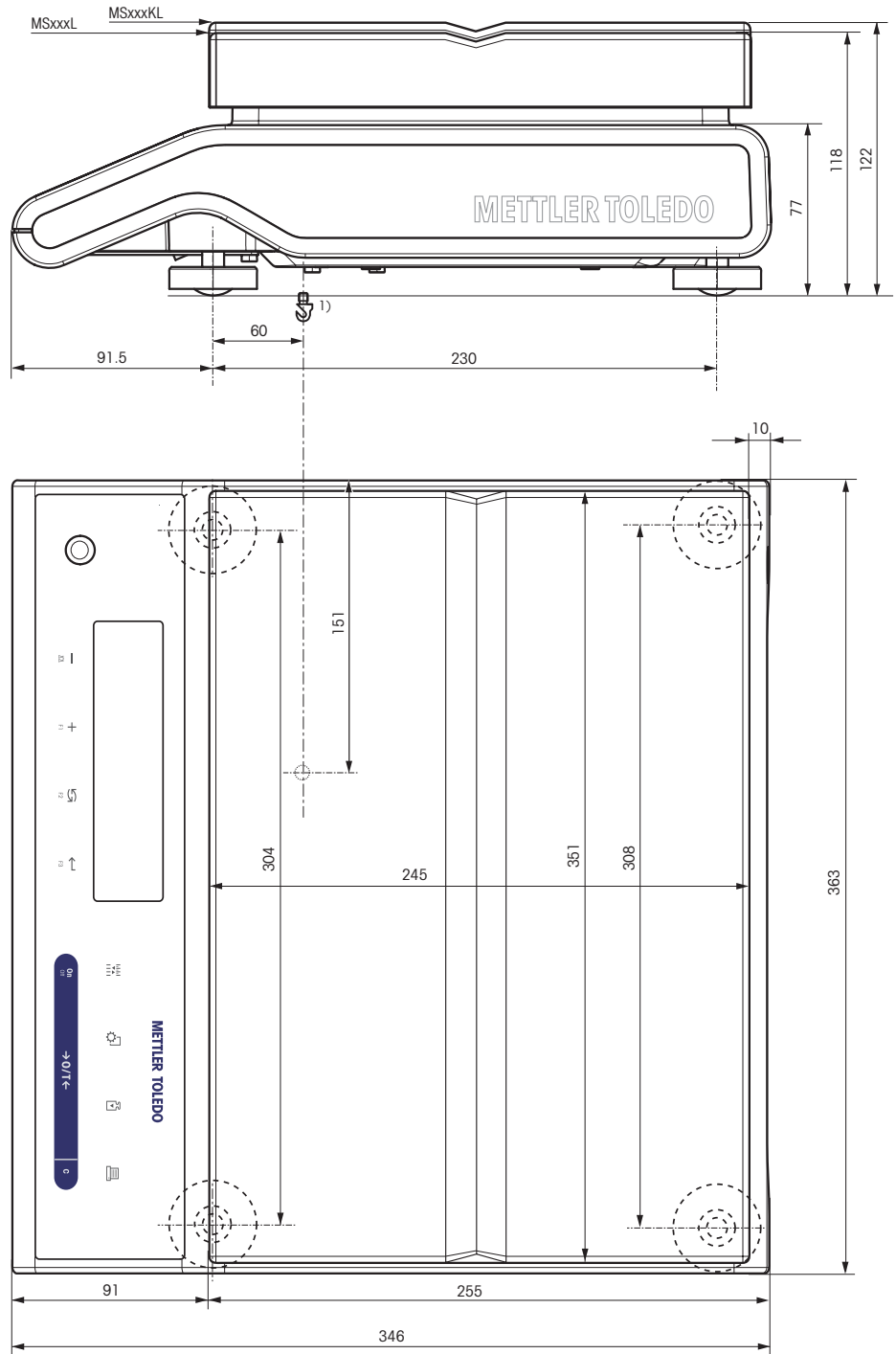

25 Accessories and Spare Parts

25.1 Accessories

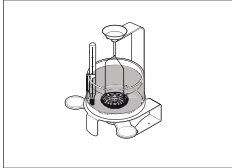
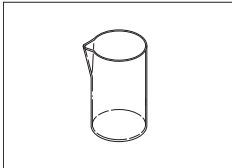
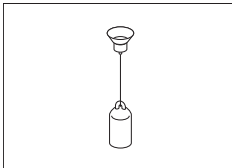
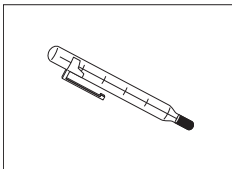
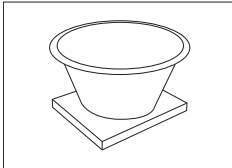
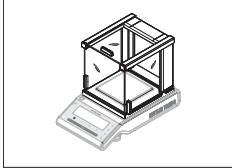
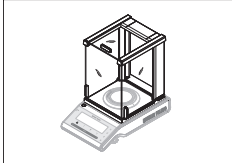
	Description	Part No.
Density Determination		
	Density kit MS-DNY-43 for NewClassic MS-S Balances (d = 0.1 mg/1 mg)	11142143
	Glass beaker, height 100 mm, Ø 60 mm	00238167
	Sinker for density of liquids in conjunction with Density Kit Calibrated (sinkers + certificate) Recalibrated (new certificate)	00210260 00210672 00210674
	Calibrated thermometer with certificate	11132685
Weighing Pans		
	Dynamic weighing pan MS-DWP-21 with 4 litre bowl (for MS-S balances with readability of 0.01 g and 0.1 g)	30006471
Draft Shields		
	Draft shield with sliding doors "mg" (usable height 168 mm)	12122405
	Draft shield with sliding doors "0.1 mg" (usable height 236 mm)	12122404

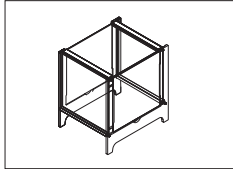

Draft shield MS-DS-21 for models with readability of 0.1 g up to 0.01 g.

12121014

Printers

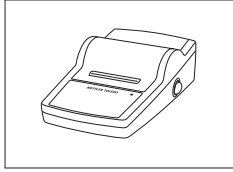

RS-P25 printer with RS232C connection to balance

11124300

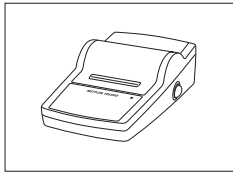

RS-P26 printer with RS232C connection to balance (with date and time)

11124303

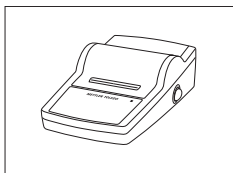

RS-P28 printer with RS232C connection to balance (with date, time and applications)

11124304

Cables for RS232C Interface

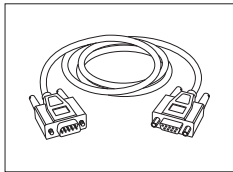

RS9 – RS9 (m/f): connection cable for PC, length = 1 m

11101051

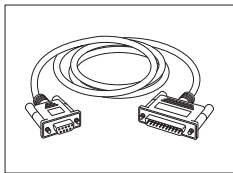

RS9 – RS25 (m/f): connection cable for PC, length = 1 m

11101052

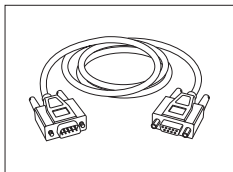

RS9 – RS9 (m/m): connection cable for devices with DB9 (f) socket, length = 1 m

21250066

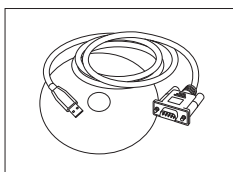

RS232 - USB converter – intelligent expansion module for connection to PC

11103691

Cables for USB Interface

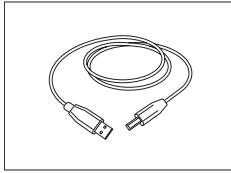

USB (A –B) connection cable for connection to PC, length = 1 m

12130716

Auxiliary Displays

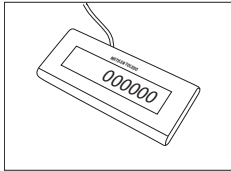

RS232 auxiliary display AD-RS-M7

12122381

Power Supplies

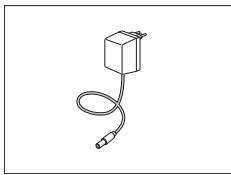

AC/DC universal adapter (EU, USA, AU, UK) 100–240 VAC, 50/60HZ, 0.3 A, 12 VDC 0.84 A

11120270

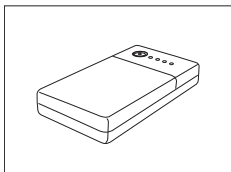

PowerPac-M-12V, for mains independent operation of balances, 12 VDC/1 A

12122363

Protective Covers

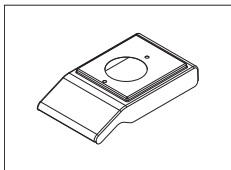

Protective cover for S platform with draft shield

12121850

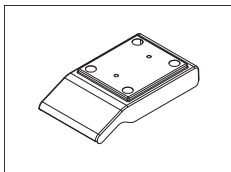

Protective cover for S platform without draft shield

12121851

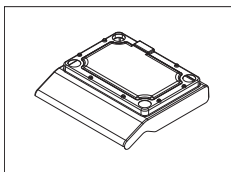

Protective cover for L platform up to "1 g"

12121852

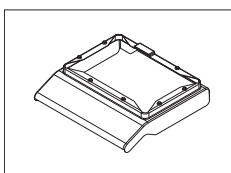

Protective cover for L platform "2–5 g"

12121853

Anti-theft Devices

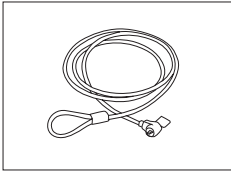

Steel cable

11600361

Software

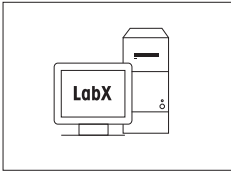

LabX direct balance (simple data transfer)

11120340

Weighing Below the Balance

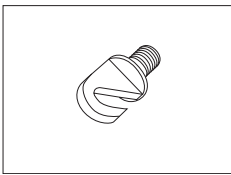

Hook for Platform L

11132565

Transport Cases

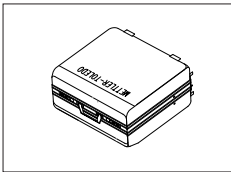

Transport case for S platform balances

11124245

Adjustment Weights



OIML / ASTM Weights (with calibration certificate) see www.mt.com/weights

25.2 Spare Parts

Draft Shield

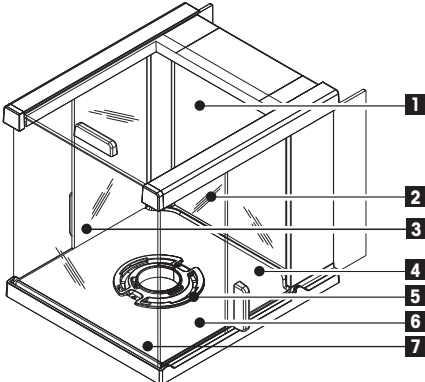
Drawing	Pos	Description	Part No.	
	5	Draft shield lock	12122013	
	6	Bottom plate	12122019	
	Draft Shield "168 mm"			
	1	Top glass with handle	12121884	
	2	Rear glass low	12122015	
	3	Side glass door left low with handle	12121881	
	4	Side glass door right low with handle	12121883	
	7	Front glass low	12122014	
	Draft Shield "236 mm"			
	1	Top glass with handle	12121884	
	2	Rear glass high	12122012	
	3	Side glass door left high with handle	12121880	
	4	Side glass door right high with handle	12121882	
	7	Front glass high	12122011	

Weighing Pans / Draft Shield Elements / Support

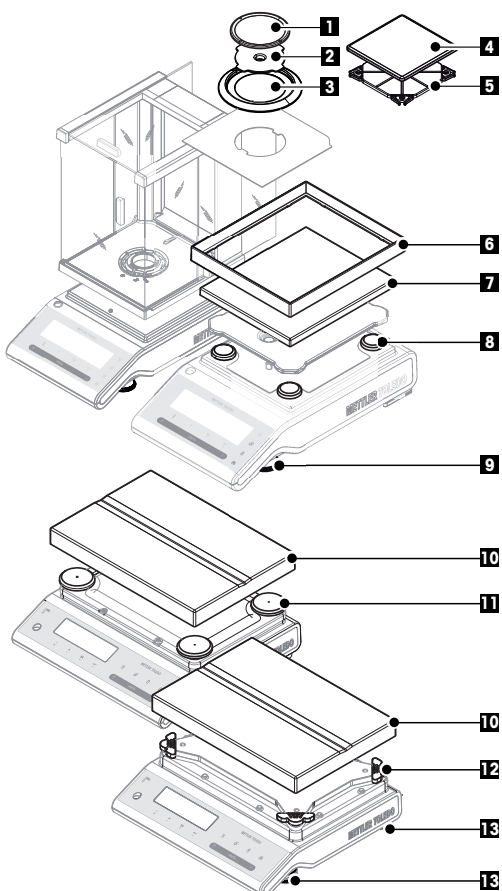
Drawing	Pos	Description	Part No.	
	For S platform			
	1	0.1 mg	Weighing pan Ø 90 mm	12122010
	2	0.1 mg	Pan support	11124249
	3	0.1 mg	Draft shield element	12122008
	4	1 mg	Weighing pan 127x127 mm	12122009
	5	1 mg	Pan support for models up to 999 g	12122017
	5	1 mg	Pan support for models from 1000 g	12122016
	6	10 mg	Draft shield element	12122018
	7	10 mg	Weighing pan 170x200 mm	11124247
	7	0.1 g	Weighing pan 190x226 mm	11124248
	8	from 10 mg	Pan support caps	11131029
	9		Leveling foot	11106323
	For L platform			
10		Weighing pan 245x351 mm	12122020	
11	to 1 g	Pan support caps	00239104	
12	from 2 g	Pan support caps	12122006	
13		Leveling foot	00230236	

26 Appendix

26.1 Conversion Table for Weight Units

Kilogram	1 kg	=	1000.0	g	1 g	=	0.001	kg
Milligram	1 mg	=	0.001	g	1 g	=	1000.0	mg
Microgram	1 µg	=	0.000001	g	1 g	=	1000000.0	µg
Carat	1 ct	=	0.2	g	1 g	=	5.0	ct
Pound	1 lb	=	453.59237	g	1 g	≈	0.00220462262184878	lb
Ounce (avdp)	1 oz	=	28.349523125	g	1 g	≈	0.0352739619495804	oz
Ounce (troy)	1 ozt	=	31.1034768	g	1 g	≈	0.0321507465686280	ozt
Grain	1 GN	=	0.06479891	g	1 g	≈	15.4323583529414	GN
Pennyweight	1 dwt	=	1.55517384	g	1 g	≈	0.643014931372560	dwt
Momme	1 mom	=	3.75	g	1 g	≈	0.266666666666667	mom
Mesghal	1 msg	≈	4.6083	g	1 g	≈	0.217	msg
Tael Hong Kong	1 tlh	=	37.429	g	1 g	≈	0.0267172513291833	tlh
Tael Singapore (Malaysia)	1 tls	≈	37.7993641666667	g	1 g	≈	0.0264554714621853	tls
Tael Taiwan	1 tlt	=	37.5	g	1 g	≈	0.0266666666666667	tlt
Tola	1 tola	=	11.6638038	g	1 g	≈	0.0857353241830079	tola
Baht	1 baht	=	15.16	g	1 g	≈	0.0659630606860158	baht

27 Index

A

Accessories; 102
Adjustment; 20; 31; 31
Advanced Menu; 27; 31
Ambient conditions; 17
Appendix; 107
Application "Check Weighing"; 47
Application "Density"; 61
Application "Diagnostics"; 35; 70
Application "Dynamic Weighing"; 55
Application "Formulation"; 51
Application "Multiplication Factor Weighing"; 57
Application "Percent Weighing"; 45
Application "Piece Counting"; 43
Application "Routine Test"; 67
Application "Statistics"; 49
Application "Totaling"; 53
Application "Weighing"; 23
Application icons; 12
Assign Application; 34; 34; 35
Auto print; 37
Automatic adjustment; 20
Automatic shutoff; 33
Automatic zero setting; 33
Autozero; 33

B

Backlight; 33
Balance history; 73
Balance information; 75
Basic menu; 27; 30
Battery operation; 19
Baudrate; 38
Beep; 30; 31
Bit/Parity; 38

C

Calibration; 20; 31
Calibration history; 74
Cancel; 29
Change settings; 28; 28
Char Set; 39; 41
Check Weighing; 47
Cleaning; 83; 83
Closing the menu; 29
Control Limit; 68
Conventions and symbols; 7
Conversion table for weight units; 107

D

Data communication format; 37; 40
Date; 30
Date format; 32
Delivery inspection; 14
DeltaRange balances; 25
Density; 61
Density kit; 61
Density table for distilled water; 65

Density table for ethanol; 66
Diagnose; 35
Diagnostics; 70
Diagnostics application; 35
Dimensions; 97
Display; 33
Display panel; 12
Display test; 71
Disposal; 8
Distilled Water; 65
Draft Shield; 15; 83; 106
Dynamic Weighing; 55

E

End of Line; 39; 41
Environment; 31
Error messages; 81
ethanol; 66
External weight; 21

F

FACT; 20; 31; 32
Factor Weighing; 57
Firmware update; 80
Formulation; 51
Fully automatic adjustment; 20; 31
Function PC-Direct; 77

G

Good Weighing Practice; 67
GWP; 67; 68

H

Handshake; 39
Header; 36

I

Icons; 12
Input principle; 28
Installing the components; 15
Interface menu; 27; 35
Interface MT-SICS commands and functions; 86
Interface RS232C; 35; 86
Interface USB device; 40; 86
Internal weight; 21
Interval; 41
Introduction; 7

K

Key assign; 34; 34; 35
Key beep; 30
Key functions; 11
Key test; 72

L

L platform overview; 10
Language; 34
Leveling the balance; 17
Line feed; 37
Liquid; 61
Liquids; 63
Location; 17

M

- Main Menu; 29
- Manual adjustment with external weight; 21
- Manual adjustment with internal weight; 21
- Menu; 27; 29
- Menu Advanced; 27; 31
- Menu Basic; 27; 30
- Menu Interface; 27; 35
- Menu operation; 28
- Menu protection; 29
- Menu topic; 28; 28; 29
- Motor test; 73
- MT-SICS interface commands and functions; 86
- Multiplication Factor Weighing; 57

N

- Net; 24
- Numerical values; 28

O

- Operation keys; 11
- Overview; 9

P

- PC-Direct; 77
- Percent Weighing; 45
- Performing a simple weighing; 24
- Piece Counting; 43
- Power supply; 18
- Print; 26
- Protect; 29
- Protocol trigger; 32

Q

- Quickstart; 23; 32

R

- Recall; 25; 32
- Repeatability test; 70
- Reset; 31
- Routine Test; 67
- RS232C interface; 35; 86

S

- S platform overview; 9
- Safety precautions; 8
- Saving settings; 29
- Select menu; 28
- Select menu topic; 28
- Selecting the location; 17
- Service; 35; 35; 83
- Service date reset; 35
- Service icon; 35
- Service provider information; 76
- Service reminder; 35
- Setting up the balance; 14
- Shutoff; 23; 33
- Signature line; 37
- Single; 37
- Sinker; 61; 63
- Software update; 80

- Solids; 61
- SOP; 68
- Spare parts; 106
- Stability beep; 31
- Startup; 23; 32
- Statistics; 49
- Status icons; 12
- Status messages; 81
- Stop bit; 39
- Submenu; 28
- Switching the balance on and off; 23
- Switching weight units; 25
- Symbols and conventions; 7

T

- Taring; 24
- Technical data dimensions; 97
- Technical data general; 89
- Technical data model-specific; 89
- Time; 30
- Time format; 32
- Topic; 28; 28; 29
- Totaling; 53
- Transmit data; 26
- Transporting the balance; 19

U

- Unit; 30; 30
- Unpacking; 14
- USB device interface; 40; 86
- USB Device Interface Installing; 78
- USB-Driver; 78

W

- Warning Limit; 68
- Weighing below the balance; 19
- Weighing made simple; 23
- Weighing-in aid; 25
- Weight unit; 25; 30; 30; 107

Z

- Zero print; 37
- Zero range; 33
- Zero setting; 24
- Zeroing; 33

GWP® – Good Weighing Practice™

The global weighing guideline GWP® reduces risks associated with your weighing processes and helps to

- choose the appropriate balance
- reduce costs by optimizing testing procedures
- comply with the most common regulatory requirements

► www.mt.com/GWP

www.mt.com/newclassic

For more information

Mettler-Toledo AG, Laboratory & Weighing Technologies

CH-8606 Greifensee, Switzerland

Tel. +41 (0)44 944 22 11

Fax +41 (0)44 944 30 60

www.mt.com

Subject to technical changes.

© Mettler-Toledo AG 01/2011

11781259E 2.12



* 1 1 7 8 1 2 5 9 *